



TRADE CATALOGUE

2015 EUROPE

preston innovations

| 2015



WELCOME TO THE 2015 PRESTON INNOVATIONS CATALOGUE

Let me take this opportunity to thank all of you for your continued support over the last twelve months. Following another successful year for the company with increased sales across the board we are pleased to unveil our portfolio of exciting new products for the forthcoming year.

This year sees a major new rod launch for Preston Innovations including the new **Mini Plus+** range which has taken the legendary Mini range to another level with new technological advancements. Also new for 2015 are the **Competition Pro** and **Carbonactive Classic** collections.

On the seatbox front we have some very exciting developments including the quite literally 'revolutionary' **OnBox 360**. Further improvements have been made to the **OnBox** range and **Space Station Compact** and all now come complete with comprehensive accessory packs.

Preston Innovations has long been synonymous with seatbox accessories and following the phenomenal year on year success of the OffBox range we are pleased to announce the arrival of **OffBox Pro** and **OffBox Pro Snap-Lok** which takes the concept to the next level with some unique features and developments.

We continually strive to improve existing products so have added **Roller Pulla Kits** into some of our pole packages and now offer a **Four Wheel Conversion Kit** for existing Two Wheel Shuttles as well as a clever **Bucket Hoop** attachment for those difficult to transport groundbait buckets.

There is a new flagship pole for Europe in the shape of the **Masterclass X7** as well as our usual selection of specialised Europe only products to ensure we cater for all markets.

We continue to innovate and the new **Pelletpults** are testament to this, featuring PTFE anti-twist technology and a purpose designed flat bottomed pouch for ultimate accuracy. We believe that for tangle-free, pinpoint feeding they are unrivalled. **Soft CAD Pots** are next generation pole friendly pots manufactured from a special hybrid material and featuring a perforated profile for increased performance.

The **Monster Luggage** range has had a complete make-over and with the addition of some new products and re-designed features looks set to be the 'must have' luggage this year, super stylish and functional. We recognise that looking good on the bank is always a consideration so check out the **DF20 Gilet** and **DF12 Suit** as well as other smart additions to our already impressive clothing range.

At Preston Innovations we strive to supply the best quality fishing tackle that has been developed to exacting standards and you will find all of the above as well as much, much more in the forthcoming pages, ultimately designed put more put more fish in the keepnet!

Scott Heens

Preston Innovations Brand Manager

FOR DETAILS ON THE FULL
PRESTON INNOVATIONS PRODUCT
RANGE, NEWS AND VIDEOS VISIT
prestoninnovations.com



@prestoninnov8



prestoninnovationslimited



UKprestoninnovations



prestoninnovations.com

EXTRASERIES PRO 2601	POLES	14
ABSOLUTE	RODS	17
	REELS	30
	SEATBOXES	34
	OFFBOX & INBOX	50
	ELASTICATION	68
2015	FLOATS	75
	HOOKS & LINE	88
	ACCESSORIES	97
SPACE MAKER	NETS & BROLLIES	112
MONSTER	LUGGAGE	118
	CLOTHING	128
	BOARDS	137

COMPATIBLE WITH NEW
**ROLLER PULLA
KIT 2**
SEE PAGE 70/71
FOR DETAILS



GiS ABSOLUTE® XS

Carrying the Absolute name would rightly lead you to believe that this pole offers something special very special. Strong, super fast and supremely stiff.

The **Absolute XS** offers the perfect balance of stiffness and power. With high wall strength, reinforced in key areas on the larger sections the **Absolute XS** offers added peace of mind – particularly when striking at longer lengths. The pole comes complete with a huge spares package comprising of a total of **5 match top 4, 5 power top 2 kits**, plus a **short four, Kup Kit and Kups**. Making a total of **ten spare kits**.

FEATURES

- Sun Core
- Fusion
- Magic Steps

ELASTIC RATING

- 16 with Power Kits
- 10 with Match Kits

PACKAGE

- 1 x GiS Absolute XS 16m Pole
- 5 x Top 4 Kits
- 5 x Power Top 2 Kits
- 1 x Short Number 4
- 1 x Kup Kit and Kups
- 1 x Holdall

TRADE QTY	
	1
CODE	DESCRIPTION
GISABXS/16M	GiS Absolute XS 16m



TOP KITS

The Genis System (GIS) was developed to satisfy UK anglers who fish on a wide range of venues. Most UK anglers need a pole that can be used for carp fishing and silver fish. Whilst all of our GiS poles can take at least a 12 elastic in the match kit, more if you remove the number 1 section, there was still a demand for stronger power kits and the GiS system was developed.

In very simple terms if you buy a Genis pole you have a huge range of different top kits to choose from, irrespective of the model chosen. These come in different strengths and lengths enabling you to personalise your pole to suit the exact fishing you do.

Also available are the GXR kits. These cost effective kits, not only represent excellent value for money, they also fit all Genis poles and come with Suncore finish.

Description	No. of Sections	Elastic Rating	Magic Step	Fusion	Sun Core
GXR POWER 2 KIT	2	UP TO 16	✓	✓	✓
GXR MATCH KITS	3 OR 4	UP TO 12	✓	✓	✓
GXR MATCH PLUS KITS	3 OR 4	UP TO 12	✓	✓	✓
GXR SHORT 4TH SECTION	1	N/A	—	—	✓
GIS POWER 2 KIT	2	UP TO 16	✓	✓	—
GIS SUPER POWER 3 KIT	3	UP TO 20	—	—	—
GIS MATCH KITS	3 OR 4	UP TO 12	✓	✓	—
GIS MATCH PLUS KITS	3 OR 4	UP TO 12	✓	✓	—
GIS SHORT 4TH SECTION	1	N/A	—	—	—
ROLLER PULLA KIT 2	2	UP TO 16	—	—	—

GIS ABSOLUTE® 11 XS

New and improved the GiS11 XS offers extreme stiffness and **excellent performance** as you would expect from any pole carrying the Absolute name, ideally suited to the angler who fishes venues ranging from commercials to canals and rivers. Built around the GIS integration system with a comprehensive spares package it also features reinforced butt sections which offer extra confidence when striking hard at longer lengths.

FEATURES

- Sun Core
- Fusion
- Magic Steps

ELASTIC RATING

- 18 with Power Kits
- 12 with Match Kits

PACKAGE

- 1 x GiS Absolute 11 XS 16m pole
- 2 x Match Top 4 Kit
- 2 x Match Top 3 Kit
- 5 x Power Top 2 Kits
- 1 x Short 4th
- 1 x Kup Kit and Kups
- 1 x Holdall

TRADE QTY	
	1
CODE	DESCRIPTION
GIS11XS/16M	GiS Absolute 11 XS



COMPATIBLE WITH NEW
**ROLLER PULLA
KIT 2**
SEE PAGE 70/71
FOR DETAILS

ROLLER



PULLAKIT
PATENT PENDING

PRESTON INNOVATIONS

THE GXR RANGE OF POLES PROVIDE INCREDIBLE PERFORMANCE COMBINED WITH FANTASTIC KIT PACKAGES AND VALUE FOR MONEY

THE FOUR MODELS IN THE RANGE COVER ALL THE IMPORTANT PRICE POINTS, AND EACH MODEL HAS BEEN SPECIFICALLY DESIGNED FOR THE UK MATCH ANGLER THAT WILL BE USING THEIR POLE ON A WIDE RANGE OF DIFFERENT VENUES. EACH OF THESE FANTASTIC POLES FEATURE ALL OF THE BENEFITS OF THE GENIS (GIS) SYSTEM, AS FOUND ON OUR TOP-OF-THE-RANGE POLES, AS WELL AS THE VERY LATEST CARBON TECHNOLOGY, INCLUDING SUN CORE FINISH AND FUSION.

GXR



GXR 2601 COMPLETE WITH 2x ROLLER PULLA KITS SEE PAGE 70/71

GXR 1601 COMPLETE WITH 2x ROLLER PULLA KITS SEE PAGE 70/71

GXR 3600 – 16M

The top of the GXR range the 3600 has many features in common with poles costing much more. Its easily fishable at its longest length and has Suncore and Fusion process included in its construction. Super stiff and light this pole is an ideal all-rounder. Supplied with comprehensive kit package which will make it ideal for serious match anglers.

ELASTIC RATING

- 18 with Power Kits
- 12 with Match Kits

PACKAGE

- 1 x GXR 3600 16m Pole
- 2 x GXR Match Top 3 kits
- 1 x GXR Match Top 4 kit
- 5 x GXR Power Top 2 kits
- 1 x Mini Extension
- 1 x Kup Kit & Kups
- 1 x Holdall

TRADE QTY

1

CODE DESCRIPTION

GXR3600/16M GXR 3600 16m

GXR 2601 – 16M

Manufactured with all the benefits of the GXR mandrel the 2601 offers a stiff powerful action suitable for a wide range of fishing situations coupled with an extensive spares package. The GXR 2601 provides the perfect solution for anglers demanding top draw performance without the need to break the bank.

ELASTIC RATING

- 18 with Power Kits
- 12 with Match Kits

PACKAGE

- 1 x GXR 2601 16m
- 2 x Match Top 3 Kits
- 2 x Power Top 2 Kits
- 2 x Roller Pulla Kits
- 1 x Mini Extension
- 1 x Kup Kit and Kups
- 1 x Holdall

TRADE QTY

1

CODE DESCRIPTION

GXR2601/16M GXR 2601 16m

GXR 1601 – 16M

At 16m the GXR 1601 offers excellent value incorporating a stiff strong action and a comprehensive spares package. Boasting features such as Suncore which can be found all the way through the GXR range. A truly outstanding pole at an affordable price.

ELASTIC RATING

- 18 with Power Kits
- 12 with Match Kits

PACKAGE

- 1 x GXR 1601 16m
- 2 x Match top 3 Kits
- 2 x Roller Pulla Kits
- 1 x Mini Extension
- 1 x Kup Kit and Kups
- 1 x Holdall

TRADE QTY

1

CODE DESCRIPTION

GXR1601/16M GXR 1601 16m

Description	No. of Sections	Elastic Rating	Magic Step	Fusion	Sun Core
GXR POWER 2 KIT	2	UP TO 16	✓	✓	✓
GXR MATCH KITS	3 OR 4	UP TO 12	✓	✓	✓
GXR MATCH PLUS KITS	3 OR 4	UP TO 12	✓	✓	✓
GXR SHORT 4TH SECTION	1	N/A	—	—	✓
GIS POWER 2 KIT	2	UP TO 16	✓	✓	—
GIS SUPER POWER 3 KIT	3	UP TO 20	—	—	—
GIS MATCH KITS	3 OR 4	UP TO 12	✓	✓	—
GIS MATCH PLUS KITS	3 OR 4	UP TO 12	✓	✓	—
GIS SHORT 4TH SECTION	1	N/A	—	—	—
ROLLER PULLA KIT 2	2	UP TO 16	—	—	—



TOP KITS

THE WHOLE RANGE OF GXR POLES CAN BE PERSONALISED BY USING THE GENIS SYSTEM (GIS) TOP KITS – WHICH ARE ALSO COMPATIBLE

GXR

ROLLER



PULLAKIT



POLES : GXR & PRO TYPE

POLES : GXR & PRO TYPE



TOP KITS
THE WHOLE RANGE OF GXR POLES CAN BE PERSONALISED BY USING THE GENIS SYSTEM (GIS) TOP KITS – WHICH ARE ALSO COMPATIBLE.



PRO TYPE POWER 9.5M AND 11M

Suitable for a variety of styles the Pro Type Power is immensely strong, making it the ideal choice for margin fishing and long line to hand fishing, its lightweight construction and quality finish make it easy to handle and the slim profile belies its strength.

PACKAGES

- 1 x Pro Type Power 9.5m pole
- 1 x Holdall
- 1 x Top 3 Kit

- 1 x Pro Type Power 11m
- 1 x Pole Holdall
- 2 x Top 3 Kit

EUROPE ONLY PACKAGES

- 1 x Pro Type Power 9.5m
- 1 x Holdall
- 1 x Short butt section
- 1 x Top Kit 4

- 1 x Pro Type Power 11m
- 1 x Pole Holdall
- 1 x Top 4 Kit

TRADE QTY	
1	
CODE	DESCRIPTION
PROPOW/9.5M	Pro Type Power 9.5m
PROPOW/11M	Pro Type Power 11m
PROPOW/9.5MEU	Pro Type Power 9.5m EUROPE ONLY
PROPOW/11MEU	Pro Type Power 11m EUROPE ONLY

PRO TYPE FEATURES

- Pro Power **reinforced butt sections** to **protect** from elbow damage when fished at longer lengths
- **Section alignment arrows** for **optimum performance**
- **Reinforced joints** to minimise carbon fatigue
- **Easy Ship finish**

PRO TYPE FEATURES

- Pro Power reinforced butt sections to protect from elbow damage when fished at longer lengths
- Section alignment arrows for optimum performance
- Reinforced joints to minimise carbon fatigue
- Easy Ship finish

POLES : PRO TYPE

POLES : PRO TYPE

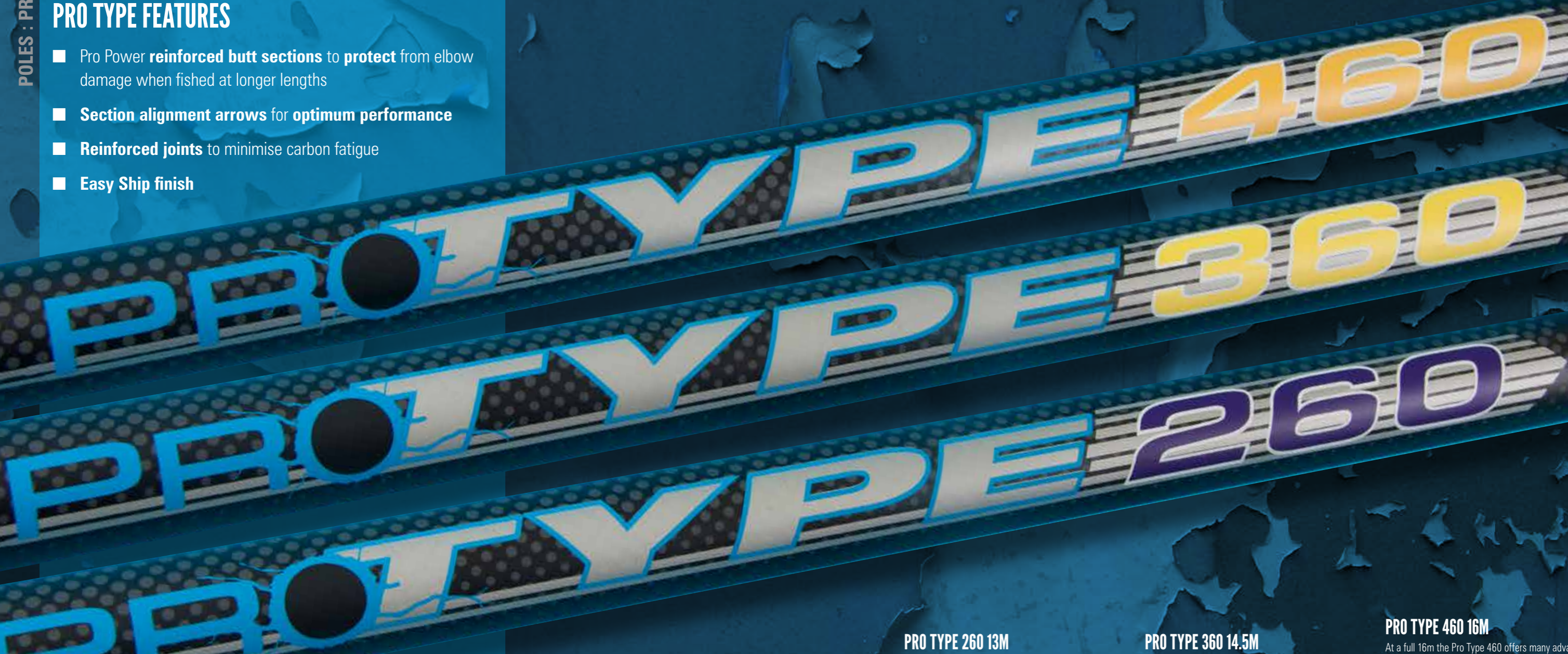

NOW COMPLETE WITH ROLLER PULLA KITS

PRO TYPE 260 13M

Supplied at 13m the Pro Type 260 is stiff and strong, ideally suited to both commercial and silver fish applications. Supplied complete with three power kits which have a reinforced area to allow the fitting of a side Pulla or Roller Pulla system (not supplied), a reinforced half butt and a Kup Kit with Kups it is the ideal choice for someone progressing into serious pole fishing. A complete pole package offering performance and outstanding value for money.

PACKAGE

- 3 x Roller Pulla Kit
- 1 x Kup kit
- 1 x Kups and Adaptors
- 1 x Half Extension
- 1 x Pole Holdall

TRADE QTY
1

CODE	DESCRIPTION
PROT260/13M	Pro Type 260 13m

PRO TYPE 360 14.5M

At 14.5m the Pro Type 360 offers the length required to reach many far bank features on canals and commercial fisheries. Its stiff action and Easy Ship finish make it ideal for all types of angler and by aligning the arrows the very best action can be achieved. Supplied with four power top 2 kits which have a reinforced area to allow the fitting of a side Pulla or Roller Pulla System (not supplied), a Kup Kit with Kups and a half butt. The perfect choice if you are looking at upgrading your current pole.

PACKAGE

- 4 x Roller Pulla Kit
- 1 x Kup Kit
- 1 x Kups and Adaptors
- 1 x Half Extension
- 1 x Pole Holdall

TRADE QTY
1

CODE	DESCRIPTION
PROT360/14.5M	Pro Type 360 14.5m

PRO TYPE 460 16M

At a full 16m the Pro Type 460 offers many advantages normally seen on poles costing much more. Super stiff and with an exceptional spares package containing 4 power kits which have a reinforced area to allow the fitting of a side Pulla or Roller Pulla system (not supplied), one additional match kit, Kup Kit with Kups, half butt and a dedicated pole holdall. This pole is a complete all-rounder and ideal for someone looking to upgrade to a top class pole without breaking the bank.

PACKAGE

- 4 x Roller Pulla Kit
- 1 x Match Top 3
- 1 x Kup Kit
- 1 x Kups and Adaptors
- 1 x Half Extension
- 1 x Pole Holdall

TRADE QTY
1

CODE	DESCRIPTION
PROT460/16M	Pro Type 460 16m

ROLLER



PULLAKIT

PRESTON INNOVATIONS





MASTERCLASS X1

This slim diameter pole is the ideal silverfish pole for any angler. Joint alignment arrows ensure the best action can be achieved and it comes supplied with a top 4 kit and an extension to enable you to comply with European length limits. All sections are finished with Easy Ship finish to make handling in any weather conditions effortless.

MASTERCLASS X1 PACKAGE

- 1 x 9.5m Pole
- 1x Top 4 Kit
- 1 x Mini Extension
- Sections: 7
- Weight: 560gr
- Elastic Rating: 0.16/No10

TRADE QTY
1

CODE	DESCRIPTION
MCX1/9.5M	Masterclass X1 9.5m

MASTERCLASS X3

Offering exceptional value for money the MasterClass X3 features a stiff balanced blank furnished with joint alignment arrows to maximise the poles action and an Easy Ship finish to assist shipping in all weather conditions. You can be confident that the X3 will not let you down regardless of whether it's a small fish race or if you have to sit and wait for a bonus fish. Each pole features classy graphics on the butt sections and a comprehensive spares package.

MASTERCLASS X3 11.5M PACKAGE

- 1 x 11.5m pole
- 1 x Top 4 kit
- 1 x Mini Extension
- Sections: 8
- Weight: 790gr
- Elastic Rating 0.16/No10

MASTERCLASS X3 13M PACKAGE

- 1 x 13.0m Pole
- 2 x Top 5 Kit
- 1 x Mini Extension
- Sections: 9
- Weight: 950gr
- Elastic Rating 0.16/No10

TRADE QTY
1

CODE	DESCRIPTION
MCX3/11.5M	Masterclass X3 11.5m
MCX3/13M	Masterclass X3 13m

MASTERCLASS X5

Preston Innovations are very proud to launch this pole exclusively for European match anglers. The stiffness and balance is exceptional, which combine to give the pole a very fast action. Perfect for those requiring the very highest level of performance from a pole, the Easy Ship finish and joint alignment system are a huge plus point for match anglers were every second counts. Available in 2 lengths and kit packages.

MASTERCLASS X5 11.5M PACKAGE

- 1 x 11.5m Pole
- 2 x Top 4 Kit
- 1 x Mini Extension
- 1 x Kup Kit & Kups
- Sections: 8
- Elastic Rating 0.16/No10

MASTERCLASS X5 13M PACKAGE

- 1 x 13.0m Pole
- 2 x Top 5 Kit
- 1 x Mini Extension
- 1 x Kup Kit & Kups
- Sections: 9
- Elastic Rating 0.16/No10

TRADE QTY
1

CODE	DESCRIPTION
MCX5/11.5M	Masterclass X5 11.5m
MCX5/13M	Masterclass X5 13m



MASTERCLASS X7

A new flagship pole designed specifically for European competition anglers. Manufactured to exacting standards on the existing 'X' mandrel it offers incredible strength and stiffness whilst remaining superbly light and responsive. Equally at home amassing big weights of bream as it is speed fishing for roach and bleak, offering optimum performance for all discerning match anglers. Complete with a comprehensive spares package tailored to European requirements.

MASTERCLASS X7 13M PACKAGE

- 1 x 13m Pole
- 3 x Top 5 Match Kit
- 1 x Top 5 Cupping Kit
- 1 x Mini Extension
- Sections: 9
- Elastic Rating: 0.16/No10

TRADE QTY
1

CODE	DESCRIPTION
MCX7/13M	Masterclass X7

MASTERCLASS TYSON

With more and more venues in Europe containing carp and even sturgeon, the demand for even stronger poles is growing.

Most of these venues are deeper than the traditional commercial lakes in the UK so require different kit packages. This means that stronger number 4 sections are required so we have upgraded the traditional 4th section (first section after the power kit).

The extra strength here gives you the confidence you need to apply the required pressure when netting fish and having a spare power top 3 enables you to use a longer length of elastic in your top sections, using a deep water pulla if required. The sections feature joint alignment arrows and Easy Ship finish to ensure optimum performance.

MASTERCLASS TYSON 11.5M PACKAGE

- 1 x 11.5m Pole
- 1 x Power Top 3 Kit
- 1 x Mini Extension
- Sections: 8
- Elastic Rating: 0.26/No20

TRADE QTY
1

CODE	DESCRIPTION
MCTYSON/11.5M	Masterclass Tyson



POWERMAX

EURO POWER POLES FOR BIG WEIGHTS AND BIG FISH!

5.5m

6.6m

7.7m

9.5m

POWERMAX 55
HIGH PERFORMANCE HIGH MODULUS CARBON CONSTRUCTION

POWERMAX 66
HIGH PERFORMANCE HIGH MODULUS CARBON CONSTRUCTION

POWERMAX 77
HIGH PERFORMANCE HIGH MODULUS CARBON CONSTRUCTION

POWERMAX ST 95
HIGH PERFORMANCE HIGH MODULUS CARBON CONSTRUCTION



POWERMAX ST 95

At 9.5m the Powermax ST offers exceptional performance and a slim blank which makes it easy to handle, ideal for bagging bream and carp on all venues. When aligned the arrows on the blank ensure optimum performance and easy section recognition due to their number marking. The strong high quality carbon is finished with an Easy Ship finish and the joints are reinforced to give added confidence in this applying pressure on this power pole.

PACKAGE

- 1 x 9.5m Pole
- 1 x Top 4 Kit
- 1 x Mini Extension
- Length: 9.5m
- Sections: 7
- Elastic Rating: 0.22mm/No 16

TRADE QTY

1

CODE DESCRIPTION

PMST/9.5M Powermax ST

POWERMAX 55/66/77

A range of high quality short poles for the European market. When fishing is limited to certain lengths there is no need to compromise on quality. Shortening a high quality long pole isn't always the right way as often the pole becomes too stiff and even too weak. The Preston Innovations Powermax poles offer you the ideal solution for all your short fishing. These poles are built on a short section mandrel and every section has an incredible wall thickness and an Easy Ship finish. Perfect for fishing down the edge for big fish and line to hand in harbours.

POWERMAX 55 PACKAGE

- Length: 5.5m
- Sections: 8
- Weight: 230g
- Elastic Rating: 0.22mm/No 16

POWERMAX 66 PACKAGE

- Length: 6.6m
- Sections: 8
- Weight: 340g
- Elastic Rating: 0.22mm/No 16

POWERMAX 77 PACKAGE

- Length: 7.7m
- Sections: 8
- Weight: 515g
- Elastic Rating: 0.22mm/No 16

TRADE QTY

1

CODE DESCRIPTION

PM55/5.5M	Powermax 55
PM66/6.6M	Powermax 66
PM77/7.7M	Powermax 77



ABSOLUTE WHIPS

A dedicated range of five lightweight telescopic whips with solid carbon flick tips, ideal for catching big numbers of small fish. Featuring a fast action tip coupled with stiffer lower sections which allows you to quickly extract small fish from the feeding shoal with minimum fuss. Classy graphics and a quality finish as you would expect from any product bearing the Absolute name.

TRADE QTY

1

CODE	DESCRIPTION
ABWHIP/2M	Absolute Whip - 2m
ABWHIP/2.5M	Absolute Whip - 2.5m
ABWHIP/3M	Absolute Whip - 3m
ABWHIP/3.5M	Absolute Whip - 3.5m
ABWHIP/4M	Absolute Whip - 4m



A range of five lightweight Telescopic Whips, ideal for catching big numbers of small fish



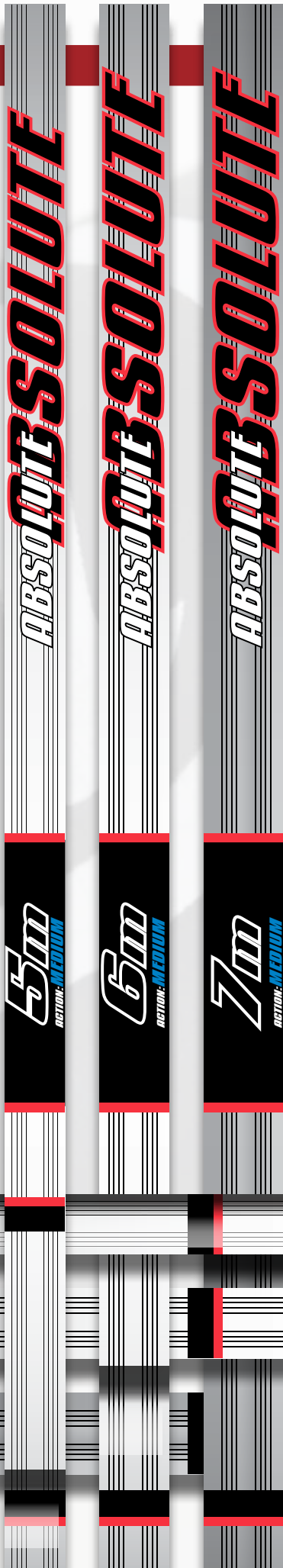

A range of six **Bolognaise Rods** offering excellent float control on running water



Quality lined guides



Lightweight snap-lock reel seat

ABSOLUTE

ABSOLUTE BOLO MEDIUM/ LIGHT

These fast actioned Bolo Rods are the ideal solution for light line fishing with floats up to 10 grams. Their high modulus carbon construction means that line pick-up on the strike is effortless. Plus the fact that they are so lightweight means that they can be held for long periods without feeling heavy. Suitable for mainlines from 2-4lb

AVAILABLE IN 5M, 6M & 7M

TRADE QTY

1

CODE DESCRIPTION

ABBR0D/01	5m
ABBR0D/02	6m
ABBR0D/03	7m

ABSOLUTE BOLO MEDIUM

Medium actioned, they are ideal for powerful flows and floats up to 16 grams. Suitable for setting bigger hooks and playing bigger fish. Their high modulus carbon construction means that line pick up on the strike is effortless and their light weight allows them to be held for long periods without them feeling heavy. Suitable for mainlines from 3-5lb.

AVAILABLE IN 5M, 6M & 7M LENGTHS

TRADE QTY

1

CODE DESCRIPTION

ABBR0D/04	5m
ABBR0D/05	6m
ABBR0D/06	7m



ABSOLUTE® 12' SUPER FLOAT

There are times when a 13ft rod is excessive or not needed, this new addition to our flagship rod range is perfect for those occasions. Incredibly light and crisp, this stunning rod has a delightful fish playing action. The delicate hollow tip cushions any sudden lunges and is ideal for light hooklengths and small hooks.

LINE RATING 2LB - 6LB

TRADE QTY
1

CODE	DESCRIPTION
CARBA/04	Absolute 12' Super Float

ABSOLUTE® 13' SUPER FLOAT

The 13ft Super Float is a beautifully refined, responsive rod, and is the result of 12 months continual development to produce a rod suitable for a world champion. The tip section features two additional guides to the standard 13ft Float, which help to provide a slightly softer but ultimately more precise action. A superb rod in every respect.

LINE RATING 2LB - 6LB

TRADE QTY
1

CODE	DESCRIPTION
CARBA/06	Absolute 13' Super Float

ABSOLUTE® 13' FLOAT

With a slightly more powerful through action compared to the Super Float, the 13ft Float is ideal for all variations of waggler fishing. The hollow tip is soft enough to cope with light hooklengths and small hooks, but seamlessly transfers the power into the mid-section when larger fish are hooked.

LINE RATING 3lb - 8lb

TRADE QTY
1

CODE	DESCRIPTION
CARBA/05	Absolute 13' Float

ABSOLUTE® 14' FLOAT

Having a similar action to the 13ft Float, the Absolute 14ft offers greater line control and casting ability, making it perfect for both rivers and stillwaters using fine hooklengths for silver fish or small carp. The fine hollow tip has a fast action that blends perfectly into the mellow actioned mid section.

LINE RATING 3LB - 8LB

TRADE QTY
1

CODE	DESCRIPTION
CARBA/07	Absolute 14' Float

ABSOLUTE® 15' FLOAT

Designed for all-round river work and distance float fishing, the 15ft Float is the perfect tool when casting performance and ultra fast line pick up are required. Featuring an advanced blend of carbon, the 15ft Float has a lightning fast tip speed that makes it suitable for delicate styles of fishing with light hooklengths and small hooks.

LINE RATING 2LB - 8LB

TRADE QTY
1

CODE	DESCRIPTION
CARBA/08	Absolute 15' Float

ABSOLUTE® 17' FLOAT

No traditional styled flagship range would be complete without a true long rod. The 17ft Float, as with the rest of the Absolute range, has a light and responsive action. Featuring a fine tip action, with stiffness and power in the butt and middle section. The guide quantity and spacing have been carefully selected to maximise performance.

LINE RATING 2.5LB - 8LB

TRADE QTY
1

CODE	DESCRIPTION
CARBA/09	Absolute 17' Float

UNTIL NOW THE NAME 'ABSOLUTE' HAS BEEN RESERVED ONLY FOR OUR VERY BEST, TOP-END POLES, BUT WHEN WE HAD OUR TEAM OF STAR CONSULTANTS LITERALLY ARGUING ABOUT WHO GOT TO USE EACH OF THE SAMPLES, THERE WAS CLEARLY ONLY ONE NAME APPROPRIATE FOR THIS STUNNING RANGE OF RODS.

ABSOLUTE® 11' 6" SUPER FEEDER

The 11ft 6" Super Feeder is real gem of a rod thanks to its forgiving action. Ideal for targeting skimmers and bream with either open ended or method feeders at venues like Porth reservoir, as well as bomb fishing in winter where the soft through action works perfectly with light hook lengths. Supplied with three balanced tips.

LINE RATING 3LB - 6LB

TRADE QTY
1

CODE	DESCRIPTION
CARBA/01	Absolute 11' 6" Super Feeder

ABSOLUTE® 12' SUPER FEEDER

Having a similar fine action to the 11ft 6" Super Feeder, but with slightly greater casting ability. This exquisite rod can be used for many applications, ranging from traditional feeder fishing for skimmers and bream, as well as winter fishing with fine hooklengths. Supplied with three precise quiver tips that cover all situations.

LINE RATING 3LB - 6LB

TRADE QTY
1

CODE	DESCRIPTION
CARBA/03	Absolute 12' Super Feeder

ABSOLUTE® 12' 6" FEEDER

The Absolute 12ft 6" Feeder offers great versatility. It can handle light hooklengths thanks to the design of the tip section, which makes it an outstanding bream or river chub rod, but also has power in the butt section which really comes into its own when a longer cast is required. Comes supplied with three carefully selected quiver tips.

LINE RATING 3LB - 8LB

TRADE QTY
1

CODE	DESCRIPTION
CARBA/02	Absolute 12' 6" Feeder

FEEDER TIPS (Ø 3.5MM)

A full range of replacement tips. They provide the perfect option for match anglers. Also fits Sentient and original Carbonactive rods.

TRADE QTY
1

CODE	DESCRIPTION
CARB/TIP10	3/4oz Glass Tip (Pink)
CARB/TIP01	1oz Glass Tip (Orange)
CARB/TIP17	1.5oz Glass Tip (Red)
CARB/TIP02	2oz Glass Tip (Yellow)
CARB/TIP18	2.5oz Carbon Tip (Yellow)
CARB/TIP03	3oz Carbon Tip (Green)
CARB/TIP14	4oz Carbon Tip (Ivory)

SUPER FEEDER TIPS (Ø 2.2MM)

There are three replacement tips suitable for the Super Feeder rods. These fine carbon tips provide bite registration - the perfect option for match anglers. Also fits Sentient and original Carbonactive rods.

TRADE QTY
1

CODE	DESCRIPTION
SENT/TIP01	Light (White)
SENT/TIP02	Medium (Red)
SENT/TIP03	Heavy (Yellow)
SENT/TIP04	Heavy (Red)





mini PLUS+

THE NEXT LEVEL OF MINI RODS

New technological advancements have facilitated increased blank strength without compromising the trademark forgiving, fish playing action which makes them first choice for commercial carp anglers. Featuring fast taper tips and an ergonomically designed soft touch reel seat, the range will cater for everything from short range method feeder fishing to long range pellet waggler fishing.



MINI PLUS 8'6" FEEDER

Designed with snake lakes in mind, this short rod is perfect for accurately casting small method or pellet feeders tight to islands, also ideal for short range open-water fishing and casts up to 30m. With its soft action and fast-taper tips it is the perfect F1 rod with strength in reserve to cope with bonus carp.

LINE RATING 3LB - 8LB

TRADE QTY
1

CODE	DESCRIPTION
PROD/04	Mini Plus 8'6" Feeder

MINI PLUS 10'6" FEEDER

A natural progression to satisfy the demand for a rod with all the qualities of the '10ft' but with increased length to cope with longer casts and larger method or pellet feeders. With a little more backbone to assist 'punching-out' a feeder it retains the fast-taper, fish playing action which helps to eliminate hook pulls.

LINE RATING 3LB - 8LB

TRADE QTY
1

CODE	DESCRIPTION
PROD/06	Mini Plus 10'6" Feeder

MINI PLUS 10' FEEDER

This is the next generation of the '10ft Mini' which is synonymous with commercial carp fishing. The blank features a progressive yet forgiving action which is strong enough to cope hard fighting carp yet balanced enough to use for skimmers with fine terminal tackle. The perfect all round feeder rod for the commercial angler.

LINE RATING 3LB - 8LB

TRADE QTY
1

CODE	DESCRIPTION
PROD/05	Mini Plus 10' Feeder

MINI PLUS 11'6" METHOD

Purpose designed for medium to long range feeder fishing this rod gives the angler confidence to launch a fully loaded method feeder in excess of 60m without compromising the rods ability to 'play' the fish and fast taper tips ensure bite registration and line pick up is still positive even at distance.

LINE RATING 3LB - 8LB

TRADE QTY
1

CODE	DESCRIPTION
PROD/07	Mini Plus 11'6" Method

MINI PLUS 11' FLOAT

The 11ft version is the optimum length for all commercial float fishing and will cover everything from standard waggler fishing to shallow pellet waggler. A true through action rod that absorbs every lunge when playing fish but retains a crisp action for precision casting that also aids responsiveness when striking.

LINE RATING 3LB - 8LB

TRADE QTY
1

CODE	DESCRIPTION
PROD/08	Mini Plus 11' Float

MINI PLUS 11'6" POWER FLOAT

The powerful blank is ideal for big weight building with pellet waggler tactics and the additional length is ideal for longer casts when fishing large 'splasher' type wagglers at distance. The progressive action will cope with everything from F1's to specimen sized match carp on larger commercials.

LINE RATING 3LB - 8LB

TRADE QTY
1

CODE	DESCRIPTION
PROD/09	Mini Plus 11'6" Power Float



CARBONTECHNOLOGY by PRECISIONENGINEERS

CARBONACTIVE



FEATURING FAST TAPER TIPS, ERGONOMICALLY DESIGNED HANDLES WITH CONCEALED LOCKABLE REEL SEATS AND HIGH GLOSS BLANKS, THE RODS ARE 'CLASSIC' IN EVERY SENSE OF THE WORD

CARBONACTIVE CLASSIC 11-13FT FEEDER

A classic configuration and seriously versatile feeder rod. At 11ft it is the perfect short range rod for all species and venues but with the addition of the 2ft extension it is transformed into a robust 13ft rod capable of distance casting with method feeders or heavy feeder fishing on fast flowing rivers.

LINE RATING 4LB - 8LB

TRADE QTY
1

CODE	DESCRIPTION
PROD/03	Carbonactive Classic 11-13ft Feeder

CARBONACTIVE CLASSIC 11FT FEEDER

The shortest rod in the range comes in its own for short to medium range feeder work and is suitable for use with bomb, method or conventional feeders. Fine fast taper tips will indicate even the shyest of bites and the progressive blank will cope with everything from small skimmers to large carp.

LINE RATING 3LB - 8LB

TRADE QTY
1

CODE	DESCRIPTION
PROD/01	Carbonactive Classic 11ft Feeder

CARBONACTIVE CLASSIC 12FT FEEDER

The 12ft model is a classic medium feeder rod, equally suited to traditional style bream fishing on large reservoirs as it is to punching out method feeders on commercials. Forgiving enough for use with fine terminal tackle and braided main line but strong enough to tame the hard fighting match carp on conventional mono.

LINE RATING 4LB - 8LB

TRADE QTY
1

CODE	DESCRIPTION
PROD/02	Carbonactive Classic 12ft Feeder

Classic SERIES

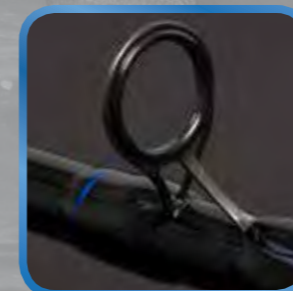

RODS : CARBONACTIVE CLASSIC

RODS : CARBONACTIVE CLASSIC

COMPETITION PRO



RODS : COMPETITION PRO

RODS : COMPETITION PRO



TO MEET THE DEMANDING REQUIREMENTS OF MODERN UK AND EUROPEAN ANGLERS

FEATURING DESIGNATED FEEDER GUIDES, IMPROVED QUIVER TIP CONFIGURATION AND A CLASSY MATT-CARBON FINISH THE BLANKS OFFER A CRISP ACTION FOR IMPROVED CASTING WHILST RETAINING FORGIVING, FISH PLAYING PERFORMANCE TO ELIMINATE HOOK PULLS. THIS PROVIDES THE DISCERNING ANGLER WITH A MORE TRADITIONAL ACTION WHICH IS PERFECT FOR ALL NATURAL STILL-WATER AND RIVER FISHING BUT EQUALLY AT HOME FEEDER FISHING ON COMMERCIALS.



9' SUPER LIGHT FEEDER

Purpose designed for use with small feeders and bombs, this is the perfect rod for short range feeder fishing up to 30m. Primarily designed as a silver fish rod, it also lends itself to light winter fishing on commercials for F1's. Super slim and responsive for use with light lines and small hooks.

LINE RATING 3LB - 6LB

TRADE QTY
1

CODE	DESCRIPTION
CPRS/01	9' Super Light Feeder

10' LIGHT FEEDER

At 10ft this rod is suitable for slightly longer casts up to around 40m and has more power in reserve for bonus fish. Suitable for all silverfish applications as well as winter fishing on commercials, the blank features a progressive tip action that is forgiving enough to cope with fine terminal tackle.

LINE RATING 3LB - 6LB

TRADE QTY
1

CODE	DESCRIPTION
CPRS/02	10' Light Feeder

11'4" LIGHT-MEDIUM FEEDER

The 11' 4" Light-Medium model is the perfect bream rod and has a deceptively strong yet soft action capable of despatching fully loaded groundbait or method feeders up to 50m. Suitable for lakes and rivers alike and has enough strength in reserve to cope with big bream and carp.

LINE RATING 4LB - 8LB

TRADE QTY
1

CODE	DESCRIPTION
CPRS/03	11'4" Light-Medium Feeder

12' MEDIUM FEEDER

Purpose designed for medium range feeder fishing and casting up to around 60m the 12' Competition Pro Feeder also doubles as a great all round feeder rod for rivers and commercials. The perfect balance of performance, strength and finesse makes this rod the ideal choice for all species.

LINE RATING 4LB - 8LB

TRADE QTY
1

CODE	DESCRIPTION
CPRS/04	12' Medium Feeder

12'6" MEDIUM-HEAVY FEEDER

For medium to long range still water feeder fishing as well as heavy feeder fishing on rivers this rod has the ability to punch big feeders a long way whilst still maintaining casting accuracy. It also has plenty of backbone to tame hard fighting big fish such as carp and barbel.

LINE RATING 4LB - 8LB

TRADE QTY
1

CODE	DESCRIPTION
CPRS/05	12'6" Medium-Heavy Feeder

13' HEAVY FEEDER

The powerful blank of the 13ft Heavy Feeder model is ideally suited to big river fishing where it is imperative the keep as much line as possible out of the flow when using large, heavy feeders. Can also double as a big fish rod for specimen sized match carp on larger commercials.

LINE RATING 6LB - 10LB

TRADE QTY
1

CODE	DESCRIPTION
CPRS/06	13' Heavy Feeder



DUTCH MASTER®



DESIGNED PRIMARILY FOR THE DUTCH MARKET, WITH THE INPUT FROM CONSULTANT ARNOU VAN DE STADT, ONE OF THE BEST LONG RANGE FEEDER ANGLERS IN EUROPE. HIS INPUT ON WHAT WAS REQUIRED HAS PROVIDED PRESTON INNOVATIONS WITH A UNIQUE RANGE OF DISTANCE FEEDER RODS THAT WE BELIEVE ARE SECOND TO NONE IN EUROPE.

DUTCH MASTER® 10' 8" FEEDER 30GRM

A short rod capable of detecting the shyest bites from small skimmers and roach its delicate tips and soft action help reduce hook pulls from these soft mouthed species whilst the blank has the required power to cast up to around 40 metres comes supplied with 3 carbon tips.

LINE RATING: 2.5LB-5LB

TRADE QTY	
1	

CODE	DESCRIPTION
CARBDM/11	Dutch Master 10'8" 30grm

DUTCH MASTER® 11' 8" FEEDER 40GRM

The Dutch Master 11' 8" comes supplied with two sensitive carbon tips and is perfect for casting up to 50 metres when catching bream and skimmers. With its softer tip action it is the ideal rod for when you have to scale down, yet still need controlled power for casting and fish-playing.

LINE RATING: 3LB-6LB

TRADE QTY	
1	

CODE	DESCRIPTION
CARBDM/05	Dutch Master 11'8" 40grm

DUTCH MASTER® 12' 8" FEEDER 60GRM

Designed for continental style feeder fishing. Capable of easily casting up to 60 metres, whilst retaining a proper fish-playing action, enabling fish of all sizes to be retrieved from distance with the minimum of fuss. Comes with two push-in tips, medium and heavy, to cope with different levels of tow.

LINE RATING: 3LB-8LB

TRADE QTY	
1	

CODE	DESCRIPTION
CARBDM/01	Dutch Master 12'8" 60grm

DUTCH MASTER® 13' 2" FEEDER 80GRM

The 13' 2" Dutch Master Feeder, combines a powerful blank, that gives you the capability to cast a fully loaded feeder up to 70 metres, along with a superb fish-playing action. Comes with two push-in tips, medium and heavy, to cope with different levels of tow.

LINE RATING: 4LB-8LB

TRADE QTY	
1	

CODE	DESCRIPTION
CARBDM/10	Dutch Master 13'2" 80grm

DUTCH MASTER® 13' 8" FEEDER 100GRM

The extra length of the 13' 8" Dutch Master Feeder, combined with a more powerful blank, gives you the capability to cast a fully loaded feeder up to 80 metres without compromising the fish-playing action.

LINE RATING: 4LB-8LB

TRADE QTY	
1	

CODE	DESCRIPTION
CARBDM/06	Dutch Master 13'8" 100grm

DUTCH MASTER® 14' 2" FEEDER 130GRM

The 14' 2" 130g Feeder can launch feeders in excess of 100 metres and can be used with large feeders on both stillwaters and rivers. Oversized guides throughout and a slim blank profile enhance casting performance.

LINE RATING: 5LB-10LB

TRADE QTY	
1	

CODE	DESCRIPTION
CARBDM/04	Dutch Master 14'2" 130grm

DUTCH MASTER® 14' 2" FEEDER 160GRM

With all the same features as the standard 14' 2", the Dutch Master 14' 2" 160grm has a more powerful blank to make casting and fishing accurately at over 100 metres a reality for the competent angler.

LINE RATING: 5LB-10LB

TRADE QTY	
1	

CODE	DESCRIPTION
CARBDM/07	Dutch Master 14'2" 160grm



DUTCH MASTER® RIVER TIPS

Dutch Master River hollow tip kits have been developed to allow owners of 13' 8" 100 gram and 14' 2" 160 gram Dutch Masters to convert their rods to carry the hollow tips. This allows them to enjoy all the benefits of the River Series on their original rods.

TRADE QTY	
1	

CODE	DESCRIPTION
CARBDM/HTK138	DM River 13' 8" Hollow Top Kit
CARBDM/HTK142	DM River 14' 2" Hollow Top Kit

HOW TO USE MEASURING STICKS



1. THIS IS WHAT YOU'LL NEED TO MARK YOUR LINE ACCURATELY



2. CLIP THE 5M CORD ONTO EACH OF THE MEASURING STICKS



3. PUSH THE STICKS INTO THE GROUND POINTING OUTWARDS, ENSURING THE CORD IS TIGHT



4. SLIDE YOUR FEEDER OVER THE TOP OF ONE OF THE MEASURING STICKS



5. WRAP YOUR LINE AROUND THE STICKS AS MANY TIMES AS NEEDED



6. MOVE THE TOGGLES ON THE CORD TO THE EXACT POINT WHERE YOU ARE FISHING



7. PLACE THE LINE UNDER THE LINE CLIP ON YOUR REEL



8. TURN EACH MEASURING STICK TO FACE INWARDS



9. KEEPING THE LINE TIGHT, REEL THE LINE OFF THE STICKS. YOU ARE NOW READY TO FISH!

MEASURING STICKS

Complete with a 3m (10ft) cord for setting out accurately, there are 2 colour coded toggle stops to enable you to mark different distances with the same set of sticks. To use, stick them in the ground at the set distance and wrap the required number of wraps around the sticks, if the distance you need to mark is less than a full wrap use the coloured markers to mark up to two ranges.

TRADE QTY	
2	
CODE	DESCRIPTION
PIMS	Measuring Sticks

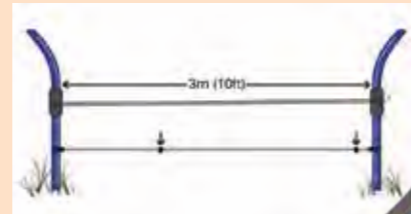

DUTCH INTERNATIONAL ANGLER, ARNOUT VAN DE STADT AT THE WORLD FEEDER CHAMPIONSHIPS 2012, WHERE HE WON SILVER INDIVIDUALLY AND TEAM GOLD

DUTCH MASTER®

DUTCH MASTER® METHOD FEEDER 11' 8"

Developed specifically for the increasing popularity of Method Feeder fishing throughout Holland and Europe. The 11ft 8 has a precise through action that offers considerable casting ability combined with fine fish playing action. Featuring a shorter handle than the standard Dutch Master range that is more suited to this style of fishing. Supplied with three precise quiver tips.

LINE RATING: 3LB - 6LB.

TRADE QTY	
1	
CODE	DESCRIPTION
CARBDM/08	Method Feeder 11' 8"
CARB/TIP01	1oz Glass Tip (Orange)
CARB/TIP17	1.5oz Glass Tip (Red)
CARB/TIP18	2.5oz Carbon Tip (Yellow)

DUTCH MASTER® METHOD FEEDER 12' 8"

With its increased length and more powerful blank, the 12ft 8" Method Feeder offers greater casting ability. A proper fish playing action has been retained, enabling fish of all sizes to be retrieved with minimum fuss. Again featuring a shorter handle than the standard Dutch Master range that is more suited to this style of fishing. Supplied with three precise quiver tips.

LINE RATING: 3LB-8LB

TRADE QTY	
1	
CODE	DESCRIPTION
CARBDM/09	Method Feeder 12' 8"
CARB/TIP01	1oz Glass Tip (Orange)
CARB/TIP17	1.5oz Glass Tip (Red)
CARB/TIP18	2.5oz Carbon Tip (Yellow)



Over-Sized Metal Line Clip

The **PC-R Competition** range has been developed to provide precision engineering and enhanced performance, combined with the feeling of power and durability.

The push button, quick release aluminium spool delivers the top quality front drag system and features an over-sized line clip for supreme confidence on the cast. Operating on 9 stainless steel ball bearing, these stunning reels are incredibly smooth, deliver superb line lay, and have all the winding power demanded by the modern match angler.

Features:

Parallel Line Lay Oscillation System

The line lay system prevents line bedding in on the spool.

Over-Sized Metal Line Clip

Features an over-sized line clip, set lower on the spool to provide supreme confidence on the cast, complete with a soft plastic insert to protect your line.

Lightweight Aluminium Body with Sealed Construction

Protects all of the internal mechanics, maximising the life of the reel.

Quick Release Push Button Spool System

Aluminium, double anodized, large arbor spool featuring a precise front drag system and quick release mechanism.

Other Features:

- Lightweight balanced rotor
- Sealed one way clutch anti-reverse system
- Sealed drag system
- 9+1 Stainless steel ball bearings
- Stainless steel hollow bail wire
- Oversized bail arm roller
- Machined gunsmoke aluminium handle and handle screw
- Soft touch handle knob
- Left and right hand retrieve
- Spare spool

READY ROD SPOOL SAFE

Protects spools when transit or in storage.

TRADE QTY

6

CODE DESCRIPTION

PRSS Ready Rod Spool Safe



PC-R COMPETITION 3000

SUPPLIED WITH A SPARE SPOOL



PC-R 3000 SPECIFICATION

GEAR RATION 5.1 : 1

WEIGHT 262g

LINE PER TURN 75cm

LINE CAPACITY 0.20mm/150m

MAX DRAG FORCE 12 kg

TRADE QTY

1

CODE DESCRIPTION

PCR/3000 PC-R 3000 Reel

PCR/3000SPOOL Spare Spool

PC-R COMPETITION 4000

SUPPLIED WITH A SPARE SPOOL



PC-R 4000 SPECIFICATION

GEAR RATIO 4.9 : 1

WEIGHT 361g

LINE PER TURN 78cm

LINE CAPACITY 0.26mm/150m

MAX DRAG FORCE 15 kg

TRADE QTY

1

CODE DESCRIPTION

PCR/4000 PC-R 4000 Reel

PCR/4000SPOOL Spare Spool

PC-R 5000 SPECIFICATION

GEAR RATIO 4.9 : 1

WEIGHT 420g

LINE PER TURN 85cm

LINE CAPACITY 0.28mm/150m

MAX DRAG FORCE 15 kg

TRADE QTY

1

CODE DESCRIPTION

PCR/5000 PC-R 5000 Reel

PCR/5000SPOOL Spare Spool

PC-R 6000 SPECIFICATION

GEAR RATIO 4.9 : 1

WEIGHT 473g

LINE PER TURN 100cm

LINE CAPACITY 0.28mm/300m

MAX DRAG FORCE 16 kg

TRADE QTY

1

CODE DESCRIPTION

PCR/6000 PC-R 6000 Reel

PCR/6000SPOOL Spare Spool

PC-R COMPETITION 5000

SUPPLIED WITH A SPARE SPOOL



PC-R COMPETITION 6000

SUPPLIED WITH A SPARE SPOOL



Following the success of our original PXR and PXR Power reels we have launched the **PXR PRO**, a comprehensive new range of reels featuring all black aluminium and graphite construction with striking red graphics and many of the features associated with reels twice as expensive.

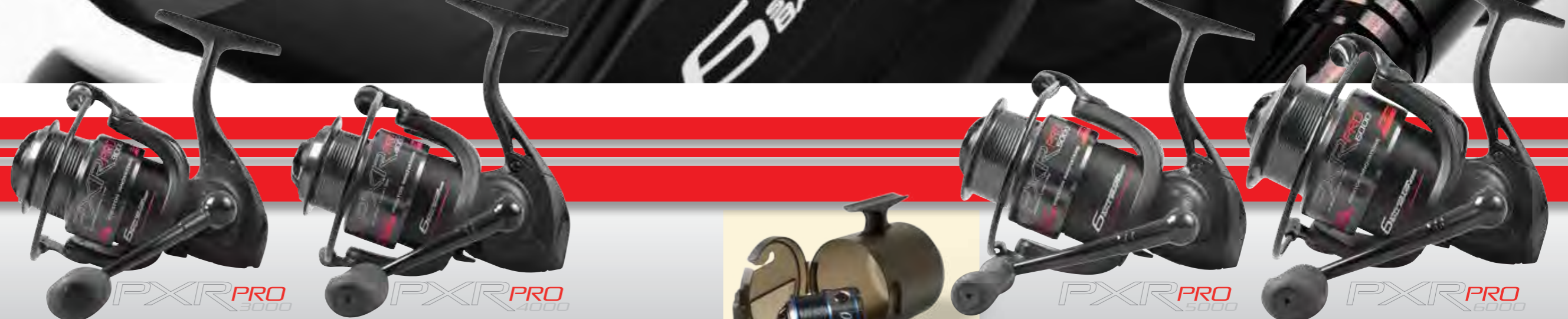

FEATURES:

- Lightweight aluminium body with sealed construction
- Quick release anodised aluminium push button spool
- 6 stainless steel ball bearings
- Stainless steel hollow bail arm
- Machined aluminium handle
- Soft touch handle knob
- Precision front drag
- Water sealed one way anti reverse system
- Graphite rotor
- Hard chrome plated line roller
- Spare anodised aluminium spool

PXR PRO 3000

GEAR RATIO: 5.1:1
LINE CAPACITY: 0.20mm/150m
WEIGHT: 252g



TRADE QTY
1

CODE	DESCRIPTION
PXRPRO/3000	PXR Pro 3000 Reel
PXRPRO/3000SPOOL	PXR Pro 3000 Spare Spool

PXR PRO 4000

GEAR RATIO: 4.9:1
LINE CAPACITY: 0.26mm/150m
WEIGHT: 341g



TRADE QTY
1

CODE	DESCRIPTION
PXRPRO/4000	PXR Pro 4000 Reel
PXRPRO/4000SPOOL	PXR Pro 4000 Spare Spool



READY ROD SPOOL SAFE

Protects spools when transit or in storage.

TRADE QTY
6

CODE	DESCRIPTION
PRRSS	Ready Rod Spool Safe

PXR PRO 5000

GEAR RATIO: 4.9:1
LINE CAPACITY: 0.28mm/150m
WEIGHT: 390g



TRADE QTY
1

CODE	DESCRIPTION
PXRPRO/5000	PXR Pro 5000 Reel
PXRPRO/5000SPOOL	PXR Pro 5000 Spare Spool

PXR PRO 6000

GEAR RATIO: 4.9:1
LINE CAPACITY: 0.28mm/300m
WEIGHT: 427g



TRADE QTY
1

CODE	DESCRIPTION
PXRPRO/6000	PXR Pro 6000 Reel
PXRPRO/6000SPOOL	PXR Pro 6000 Spare Spool

ABSOLUTE STATION

ABSOLUTE STATION

SEATBOXES : ABSOLUTE STATION



A RADICALLY RE-DESIGNED, LIGHTER FRAME. WORKING WITH OUR CONSULTANTS WE'VE INCORPORATED MANY NEW FEATURES CULMINATING IN OUR MOST USER-FRIENDLY STATION SYSTEM TO DATE...

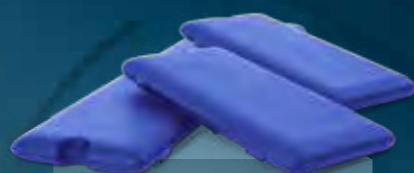

COMPLETE WITH
3 HOOKLENGTH BOXES
Complete with two small and one large hooklength retaining system



INCLUDES
SHUTTLE ADAPTER
Adapts the current Space Station Shuttle (SPST/09) and Four Wheeled Shuttle (SPST/16) to allow secure and easy transportation of the Absolute Station.
(Shuttle not included)



CONCEALED DRAWER UNIT, WITH MAGNETIC PUSH RELEASE. PLUS UNIQUE HOOKLENGTH STORAGE SOLUTION UNDER THE LID.

COMPLETE WITH TWO SMALL AND ONE LARGE HOOKLENGTH RETAINING SYSTEM

LARGER LEGS STILL OFFBOX COMPATIBLE
The legs are a new larger 30mm diameter which helps to make the Absolute Station ultra-stable. Compatible with all existing OffBox accessories, simply attach without an insert fitted. These new legs are mounted as low as possible to the ground meaning you can make your seated position super-low if required.

UNDERCOVER: REMOVABLE FOOTPLATE
The removable footplate is perfect for those situations where you don't need a footplate, like narrow towpaths or man-made platforms. The plastic cover makes it easier to clean down your box after a session on the bank. A cleaner box will ultimately last longer and make your fishing more efficient. Remove the footplate during transit and you've got plenty of space left in the car.

THE FULL MONTY
We're offering the complete package, to satisfy consumer customers' needs, also includes a conversion kit for users of our latest shuttles.
Plus two small and one large hooklength box which clip neatly under the seat and carrying lid. This setup is sure to generate add-on sales for any serious match angler.



ABSOLUTE STATION

FEATURES

- Low to the ground
- Integral spirit level
- Removable, covered footplate
- Anti-sag hand wheels
- Shuttle adaptors
- 30mm legs
- Concealed front drawer
- Under seat storage for 3 hooklength boxes (included)
- Adaptable modular storage solution

SUPPLIED WITH

- 1 x Seatbox Cover
- 1 x Deep Side Drawer (40mm deep)
- 1 x Concealed Front Drawer with Magnetic Release Catch (40mm deep) fixed to the top of the frame
- 1 x Shallow Tray (26mm)
- 1 x Shallow Unit (26mm)
- 1 x Deep Storage Unit (100mm)

TRADE QTY	
1	
CODE	DESCRIPTION
ABST/01	Absolute Station Seatbox

SEATBOX COVER INCLUDED



ABSOLUTE COMPACT



SEATBOX COVER INCLUDED

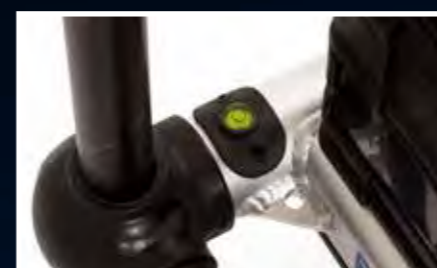

COMPLETE WITH WINDERS

ABSOLUTE COMPACT

FEATURES

- Integral spirit level
- Removable, covered footplate
- Anti-sag hand wheels
- Shuttle adaptors
- 30mm Telescopic legs
- Under seat storage for 3 hooklength boxes (included)
- Adaptable modular storage solution
- Deep Frame Mounted Base

SUPPLIED WITH

- 1 x Deep Side Drawer (40mm deep)
- 1 x Shallow Unit (26mm complete with 18cm winders)
- 1 x Seat Cover
- 1 x Deep Storage Unit (Frame mounted)

TRADE QTY	
1	
CODE	DESCRIPTION
ABST/17	Absolute Compact

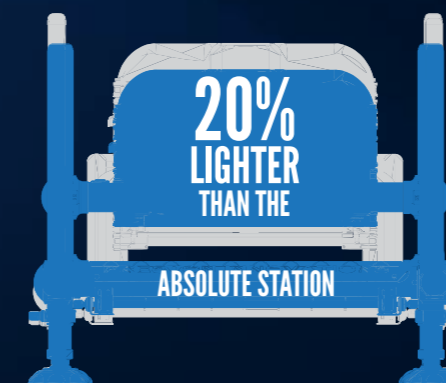

ABSOLUTE STATION SPARE LEGS

Ideal for customising your box. Long (750mm) are ideal for wading situations and side tray support legs when fishing from platforms. Standard (500mm) provide a direct replacement for the legs of the seatbox or side trays on flat terrain. Short (350mm) replace legs when the longer length hinders movement around your peg. LEGS ARE SUPPLIED UNIVERSAL WHICH CAN EASILY BE CHANGED BY REMOVING THE FOOT AND REFITTING THE OPPOSITE WAY AROUND.

TRADE QTY	
1	
CODE	DESCRIPTION
ABST/13	Standard 50cm Telescopic Leg
ABST/14	Short 35cm Telescopic Leg
ABST/15	Long 75cm Telescopic Leg

XL BANKSTICKS

Compatible with OffBox accessories, the XL Banksticks feature the 30mm Absolute profile and provide an ultra stable solution to attaching keepnets, rod rests and other seatbox accessories.

AVAILABLE IN 125MM & 250MM

TRADE QTY	
5	
CODE	DESCRIPTION
OFFBOX/102	125mm
OFFBOX/103	250mm



SEATBOX COVER

A water-resistant cover for Absolute seatboxes.

TRADE QTY	
1	
CODE	DESCRIPTION
ABST/20	Absolute Seatbox Cover

40MM DEEP TRAY

Loaded with 26cm Wide Winders

TRADE QTY
1

CODE	DESCRIPTION
ABST/16	40mm Deep Tray - with 26cm Wide Winders

26MM SHALLOW UNIT

Loaded with 13cm Winders

TRADE QTY
1

CODE	DESCRIPTION
ABST/08	26mm Shallow Unit - with 13cm Winders

100MM UNIT

TRADE QTY
1

CODE	DESCRIPTION
ABST/04	100mm Unit

26MM SHALLOW UNIT

TRADE QTY
1

CODE	DESCRIPTION
ABST/02	26mm Shallow Unit

26MM SHALLOW SIDE DRAWER UNIT

TRADE QTY
1

CODE	DESCRIPTION
ABST/05	26mm Shallow Side Drawer Unit

40MM SIDE DRAWER UNIT

TRADE QTY
1

CODE	DESCRIPTION
ABST/07	40mm Side Drawer Unit

ABSOLUTE COMPACT FRAME ONLY

Available separately the Absolute Compact Frame is ideal for owners of Absolute Stations who wish to convert their existing seatbox or those wishing to 'custom build' their own Compact Station. The frame comes supplied with 4 x 450mm legs and a cassette bar for attaching the footplate which is also available separately.

TRADE QTY
1

CODE	DESCRIPTION
ABST/18	Absolute Compact Frame only

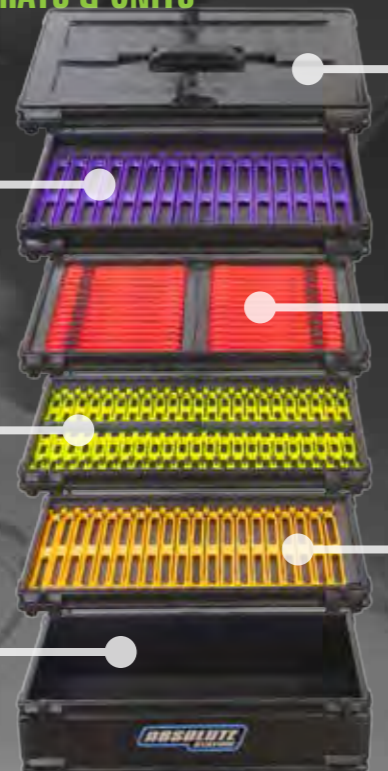

LID WITH HANDLE

TRADE QTY
1

CODE	DESCRIPTION
ABST/12	Lid with Handle

26MM SHALLOW UNIT

Loaded with 18cm Winders

TRADE QTY
1

CODE	DESCRIPTION
ABST/09	26mm Shallow Unit - with 18cm Winders

26MM SHALLOW UNIT

Loaded with 26cm Narrow Winders

TRADE QTY
1

CODE	DESCRIPTION
ABST/10	26mm Shallow Unit - with 26cm Narrow Winders

SEAT

TRADE QTY
1

CODE	DESCRIPTION
ABST/11	Seat

40MM SIDE WINDER DRAWER UNIT

TRADE QTY
1

CODE	DESCRIPTION
ABST/19	40mm Side Winder Drawer Unit

40MM CONCEALED FRONT DRAWER UNIT

TRADE QTY
1

CODE	DESCRIPTION
ABST/06	40mm Concealed Front Drawer Unit

40MM UNIT

TRADE QTY
1

CODE	DESCRIPTION
ABST/03	40mm Unit

FOOTPLATE ONLY

Including 2 legs.

TRADE QTY
1

CODE	DESCRIPTION
ABST/21	Absolute Compact Footplate only

BUILD IT YOUR OWN WAY



COMMERCIAL

With front and side drawer configuration and an additional winder tray stacking system this option is the perfect solution for the commercial angler.

CODE	DESCRIPTION
ABST/12	Lid with Handle
ABST/09	26mm Shallow Unit (loaded with 18cm winders)
ABST/08	26mm Shallow Unit (loaded with 13cm winders)
ABST/10	26mm Shallow Unit (loaded with 26cm narrow winders)

CODE	DESCRIPTION
ABST/11	Seat
ABST/06	26mm Shallow Side Drawer Unit
ABST/05	40mm Concealed Front Drawer Unit
ABST/07	40mm Side Drawer Unit
ABST/18	Absolute Compact Frame only
ABST/21	Footplate only

THE ABSOLUTE COMPACT MODULAR SYSTEM ALLOWS YOU THE ANGLER TO CUSTOM BUILD YOUR OWN SEAT BOX TO YOUR EXACT SPECIFICATION. WITH A WIDE RANGE OF WINDER TRAYS, DRAWERS AND UNITS AVAILABLE YOU CAN TAILOR YOUR PERSONAL CONFIGURATION TO SUIT YOUR OWN FISHING REQUIREMENTS.

ALL MODULES ARE COMPATIBLE WITH THE ABSOLUTE STATION AND THE ABSOLUTE COMPACT



CANAL

When minimal gear is required this lightweight and practical option still provides adequate winder storage and is perfect for the towpath enthusiast.

CODE	DESCRIPTION
ABST/11	Seat
ABST/06	40mm Concealed Front Drawer Unit
ABST/09	26mm Shallow Unit (loaded with 18cm winders)
ABST/08	26mm Shallow Unit (loaded with 13cm winders)
ABST/18	Absolute Compact Frame only
ABST/21	Footplate only



RIVER

Travel light on the river bank with a combination of winder trays, a deep side drawer and a separate deep base stacking unit for transporting feeders and reels.

CODE	DESCRIPTION
ABST/12	Lid with Handle
ABST/03	40mm Unit
ABST/04	100mm Unit

CODE	DESCRIPTION
ABST/11	Seat
ABST/06	40mm Concealed Front Drawer Unit
ABST/16	40mm Deep Tray (loaded with 26cm wide winders)
ABST/08	26mm Shallow Unit (loaded with 13cm winders)
ABST/18	Absolute Compact Frame only
ABST/21	Footplate only

SEATBOXES : ONBOX 360

SEATBOXES : ONBOX 360

FEATURES:

- **INTEGRAL EVA SIDE TRAY** - Twin knuckled EVA side tray that stows away under the frame for easy transportation (will accommodate 3 x Large 5pt bait tubs)
- **TELESCOPIC LEGS** - Four independently telescopic legs for optimum positioning on uneven ground
- **FOLDING PADDED SEAT** - Comfortable, fully rotating and cushioned with retaining strap for storage
- **STORAGE COMPARTMENT** - Under seat storage compartment that is fully OnBox compatible, with the facility to add more trays if required
- **OFFBOX ACCESSORY POINTS** - Two location points for attaching OffBox accessories (use for storing EVA Side Tray whilst in transit)
- **SHOULDER STRAP** - Comes complete with adjustable padded shoulder strap and carry handle



Seat back folds down for easy transportation and storage.



ONBOX 360

A revolutionary new concept in seatbox technology, featuring a padded, fully rotating seat with cushioned backrest. No more straining to reach that tricky margin swim or twisting your back uncomfortably in awkward confined pegs. It provides all the comfort of a chair with the functionality of a seatbox and the ability to rotate to any given position. Lightweight and easy to transport with padded shoulder strap and rigid carry handle, the OnBox 360 is fully compatible with OnBox/Space Station Add-On units. Perfect for float, feeder or pole fishing.

TRADE QTY	
1	
CODE	DESCRIPTION
ONBOX/89	Onbox 360



BE PART OF THE
REVOLUTION

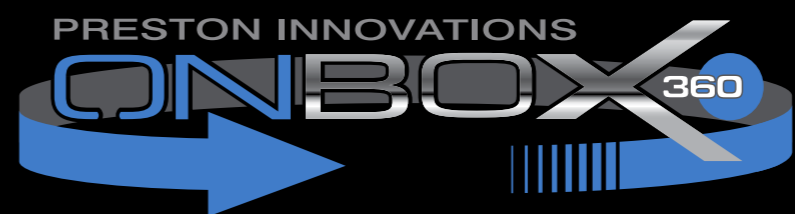

THE INNOVATIVE
ROTATING SEATBOX

FOLDING BACK-REST SEAT
IS ALSO AVAILABLE FOR ONBOX AND COMPACT XS SEATBOXES
SEE PAGE 42

XS POLE SEAT

Pole seat with pole retaining strap.

TRADE QTY	1
CODE	DESCRIPTION
ONBOX/58	XS Pole Seat

XS SHALLOW SIDE DRAWER UNIT

20mm shallow through drawer unit.

TRADE QTY	1
CODE	DESCRIPTION
ONBOX/56	XS Shallow Side Drawer Unit

XS STACKING UNIT LID

Attaches to any unit in the range, complete with carrying handle.

TRADE QTY	1
CODE	DESCRIPTION
ONBOX/61	XS Stacking Unit Lid

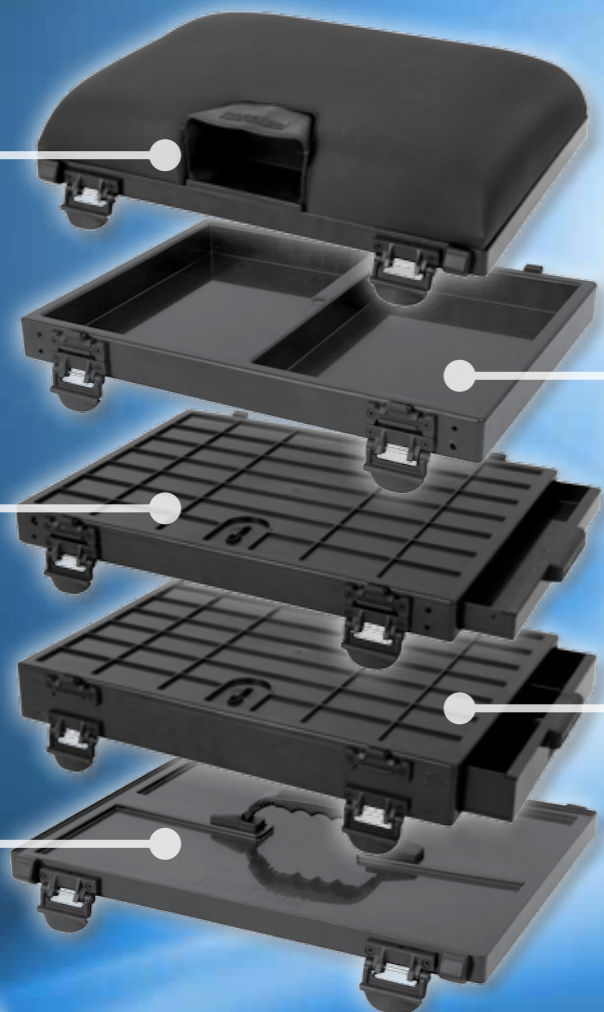

XS 2 COMPARTMENT SHALLOW ADD ON UNIT

25mm deep shallow add on unit, divided to fit the InBox pop-up winder trays. Available with or without runners.

TRADE QTY	1
CODE	DESCRIPTION
ONBOX/55	XS 2 Compartment Shallow Add On Unit without runners
ONBOX/60	XS 2 Compartment Shallow Add On Unit with runners

XS DEEP SIDE DRAWER UNIT

40mm shallow through drawer unit.

TRADE QTY	1
CODE	DESCRIPTION
ONBOX/57	XS Deep Side Drawer Unit



ONBOX FOLDING BACK REST SEAT

OnBox and Space Station* compatible padded seat with folding backrest. Replaces existing seat to provide comfort and support whilst still allowing the angler to fish comfortably with rod and line or pole.

PLEASE NOTE THIS SEAT IS FIXED AND DOES NOT ROTATE

TRADE QTY	1
CODE	DESCRIPTION
ONBOX/88	OnBox Folding Back Rest Seat

* only compatible with models with plastic locking clips



TELESCOPIC LEGS

Replacement legs suitable for Space Station Compact XS and OnBox Series 5 Seatboxes.

TRADE QTY	1
CODE	DESCRIPTION
ONBOX/90	40cm XS Onbox Telescopic Legs
ONBOX/91	65cm Space Station Telescopic Legs



SPACE STATION COMPACT XS



ARTICULATED, EXTRA WIDE MUD FEET | BUILT-IN SOFT TOUCH, RUBBERISED POLE HOOK | ANODISED LEG WITH THREADED INSERT

SPACE STATION COMPACT XS

Sporting a contemporary graphite finish, the new Space Station Compact XS incorporates a redesigned pole seat for positive pole location, ultra-stable leg blocks and non-marking anodised legs, two of which feature threaded end caps for locating rod rests and other accessories. Providing total compatibility with existing add on units it comes complete with fixed winder tray, deep side drawer and removable deep storage tray and offers a positive solution for the space conscious angler.

COMPLETE WITH ACCESSORY PACK WORTH OVER £75 AT RRP INCLUDING:

- 2 x OffBox Pro Snap-Lok Short Keepnet Arms
- Large OffBox Pro Side Tray
- Seat Box Cover
- Leg Levellers
- 2 x Double Slider Winder Trays

TRADE QTY	1
CODE	DESCRIPTION
SPST/20	Space Station Compact XS

TRADE QTY	1
CODE	DESCRIPTION
ONBOX/86	OnBox Series 5 / Compact XS Pole Seat only



ACCESSORY PACK

INCLUDED WITH EACH BOX WORTH OVER £75 AT RRP INCLUDES:

- 2 x OffBox Pro Snap-Lok Short Keepnet Arms
- Large OffBox Pro Side Tray
- Seat Box Cover
- Leg Levellers
- 2x Double Slider Winder Trays



WITH SLIDER WINDER TRAYS

ONBOX 3D

SERIES FIVE

FEATURES

- 1 x Deep Side Drawer Unit
- 1 x Deep Winder Drawer Unit
- 1 x Double Winder Tray

ACCESSORY PACK WORTH OVER £75 AT RRP INCLUDING:

- 2 x OffBox Pro Snap-Lok Short Keepnet Arms
- Large OffBox Pro Side Tray
- Seat Box Cover
- Leg Levellers
- 2 x Double Slider Winder Trays

TRADE QTY
1

CODE	DESCRIPTION
ONBOX/83	OnBox Series Five 3D

TRADE QTY
1

CODE	DESCRIPTION
ONBOX/86	OnBox Series 5 / Compact XS Pole Seat only

THE 5TH GENERATION OF ONBOX

ONBOX

SERIES FIVE

WITH NEW ULTRA STABLE LEG BLOCK, NON-MARKING ANODISED LEGS (TWO OF WHICH HAVE THREADED END CAPS) AND RE-DESIGNED POLE SEAT, THE FIFTH GENERATION OF ONBOX NOT ONLY LOOKS SUPER STYLISH BUT ALSO OFFERS ULTIMATE PERFORMANCE. NOW COMPLETE WITH LEG LEVELLERS TO ENABLE CORRECT POSITIONING EVERY TIME AND RE-CONFIGURED DRAWER LAYOUT TO OPTIMISE THE AVAILABLE SPACE



ACCESSORY PACK

INCLUDED WITH EACH BOX WORTH OVER £75 AT RRP INCLUDES:

- 2 x OffBox Pro Snap-Lok Short Keepnet Arms
- Large OffBox Pro Side Tray
- Seat Box Cover
- Leg Levellers
- 2 x Double Slider Winder Trays



ONBOX SERIES FIVE FEATURES:



CONTEMPORARY NEW LOOK



ARTICULATED, EXTRA WIDE MUD FEET



BUILT-IN SOFT TOUCH, RUBBERISED POLE HOOK



ANODISED LEG WITH THREADED INSERT

ONBOX 4D

SERIES FIVE

FEATURES

- 1 x Deep Side Drawer
- 1 x Deep Winder Drawer
- 2 x Deep Front Drawers

ACCESSORY PACK WORTH OVER £75 AT RRP INCLUDING:

- 2 x OffBox Pro Snap-Lok Short Keepnet Arms
- Large OffBox Pro Side Tray
- Seat Box Cover
- Leg Levellers
- 2 x Double Slider Winder Trays

TRADE QTY
1

CODE	DESCRIPTION
ONBOX/84	OnBox Series Five 4D



ONBOX 5D

SERIES FIVE

FEATURES

- 1 x Deep Side Drawer
- 1 x Deep Winder Drawer
- 1 x Shallow Winder Drawer
- 2 x Deep Front Drawers

ACCESSORY PACK WORTH OVER £75 AT RRP INCLUDING:

- 2 x OffBox Pro Snap-Lok Short Keepnet Arms
- Large OffBox Pro Side Tray
- Seat Box Cover
- Leg Levellers
- 2 x Double Slider Winder Trays

TRADE QTY
1

CODE	DESCRIPTION
ONBOX/85	OnBox Series Five 4D



MONSTER FEEDER CHAIR

MONSTER FEEDER CHAIR

Incorporates adjustable legs that can be used with the OffBox range of products to offer a complete fishing station. With its comfortable, generously padded and re-reinforced cover, the chair offers the ideal posture for feeder fishing. Using the vast array of existing OffBox accessories to customise your fishing station, you can not only fish more efficiently, but keeping your gear organised will help you to stay on top of your game.

TRADE QTY
1

CODE	DESCRIPTION
PMFCHAIR/01	Monster Feeder Chair

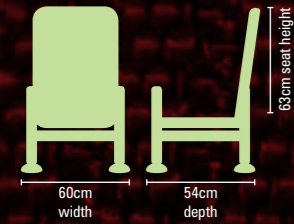

DESIGN ALLOWS THE BACKREST TO FOLD DOWN FOR EASIER TRANSPORT AND STORAGE

PADDED SEAT OFFERS SUPERB COMFORT

ADJUSTABLE LEGS ALLOW ANGLERS TO TACKLE THE MOST UNEVEN BANKS WITH EASE - SIMPLY LEVEL EACH LEG

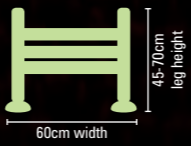

MONSTER FEEDER CHAIR FOOTPLATE

Attach keepnets and other accessories to your footplate legs using the vast array of existing OffBox accessories to customise your fishing station.

TRADE QTY
1

CODE	DESCRIPTION
PMFCHAIR/02	Monster Feeder Chair Footplate



LOTS OF GEAR TO TRANSPORT? THEN YOU NEED A PRESTON INNOVATIONS TROLLEY

You can load it up with all of your gear and because of their unique designs they're still easy to load and push.

ONBOX TROLLEY

The OnBox Trolley can be fitted to any OnBox seatbox in seconds, without the legs of the box being removed. Once in use the weight of the box is balanced over the two puncture proof moulded EVA tyres to make transporting easy.

TRADE QTY
1

CODE	DESCRIPTION
ONBOX/12	Onbox Trolley

OFFBOX UNIVERSAL TROLLEY

Suitable for the complete OnBox range, Space Stations and other manufacturers seatboxes. Features adjustable height solid wheels and base load area, and a carryall bar with integrated loops for securing bungee straps. Quick and easy to dismantle for transportation.

TRADE QTY
1

CODE	DESCRIPTION
OFFBOX/79	Universal Trolley



2-PIECE PLATFORM

Features a large lightweight aluminium area which breaks down into two pieces for easy transport. Large enough to accommodate our Absolute Station seat box along with many other manufacturers' boxes, the larger profile legs offer a super stable fishing platform and is compatible with OffBox accessories. The complete fishing station.

W: 840MM H: 740MM

TRADE QTY
1

CODE	DESCRIPTION
PFORM1	2-Piece Station Platform



NEW LARGER SIZE



FOUR WHEELED SHUTTLE

Takes the strain out of getting your gear to your pegs. The support bar is fully adjustable to suit our OnBox and Space Station designs and it can also be turned around making the shuttle suitable for a wide range of other boxes. With four wheels supporting its entire weight it's simply a matter of pushing it to your peg. The problem of punctures is eliminated by the solid tyres which can be adjusted to give more ground clearance. The whole shuttle can be disassembled for packing into your car or storing at home. Comes complete with a load compartment which is ideal for transporting clothing or bait.

TRADE QTY	
1	
CODE	DESCRIPTION
SPST/16	Four Wheeled Shuttle



SPACE STATION SHUTTLE GROUND BAIT BUCKET HOOP

Purpose designed to accommodate most groundbait buckets and makes it easier to load your shuttle. Front loading to transfer and distribute weight, which improves balance and makes your shuttle easier to push.

- Fits 2 and 4 Wheel Shuttles*
- Will accommodate 17-25 litre buckets
- Instant fit
- Transfers weight for ease of use
- Angled for optimum performance

TRADE QTY	
1	
CODE	DESCRIPTION
SPST/18	Groundbait Bucket Hoop

*models with removable front bar only



SPACE STATION / ONBOX SHUTTLE

Developed to carry the Space Station, Xbox and other seatboxes using the supplied converter. Provides a large luggage loading area for carryalls and an additional removable Utility Bag between the handles for extra storage. In addition, the handle bar system incorporates a foam covered cross bar that can be used to support rod holdalls.

Once loaded, the angler can transport a complete set of tackle with ease compared to traditional seatbox trolleys. This has been achieved by positioning the wheels directly beneath the heaviest part of the loaded shuttle, giving optimum balance. Can be quickly assembled and dismantled to fit comfortably inside most car boots.

TRADE QTY	
1	
CODE	DESCRIPTION
SPST/09	Space Station Shuttle
SPST/10	Utility Bag Only (spare)



4 WHEEL SHUTTLE CONVERSION KIT

Converts existing two wheeled shuttles in to four wheeled versions.

- Easy to fit
- Fully load bearing
- Optional 2 or 4 wheel use
- Improved stability

INCLUDES: 2X ADAPTORS & 2X WHEELS

TRADE QTY	
1	
CODE	DESCRIPTION
SPST/19	4 Wheel Shuttle Conversion

OFFBOX PRO

OFFBOX PRO AND OFFBOX PRO SNAP-LOK IS THE NEXT GENERATION OF SEAT-BOX ACCESSORY AND IS A NATURAL EVOLUTION OF THE EXISTING OFFBOX RANGE OF PRODUCTS. WITH UNIQUE DESIGN FEATURES AND DEVELOPMENTS WE CONTINUE TO INNOVATE, NOT IMITATE!



OFFBOX PRO SNAPLOK

SNAP-LOK QUICK RELEASE CAM - FOR EASE OF ASSEMBLY AND INTERCHANGEABILITY LEAVE THE KNUCKLE ATTACHED TO THE SEAT BOX LEG AND SIMPLY SNAP ON THE APPROPRIATE ACCESSORY. MAKES TACKLING UP AND PACKING AWAY QUICK AND SIMPLE AND ALLOWS ACCESSORIES TO BE REMOVED OR CHANGED WHILST IN USE.

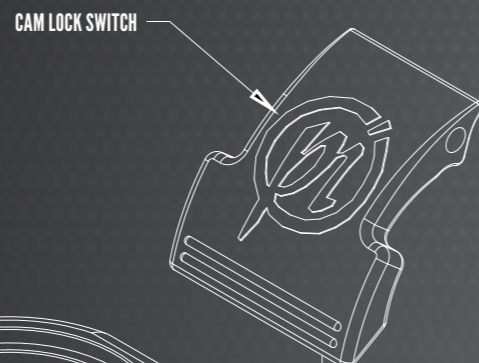
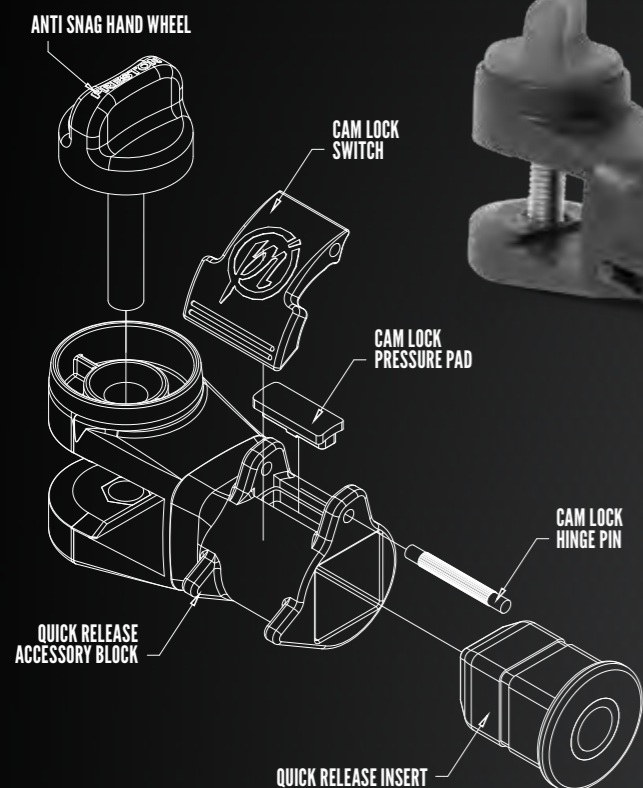

ANTI-SNAG HAND WHEELS - NEW ERGONOMICALLY DESIGNED AND FEATURING SOFT RUBBERISED FINISH, THE HANDWHEEL CONVENIENTLY LOCATES WITHIN THE KNUCKLE TO AVOID TRAPPING LINE AND TERMINAL TACKLE WHILST FISHING.

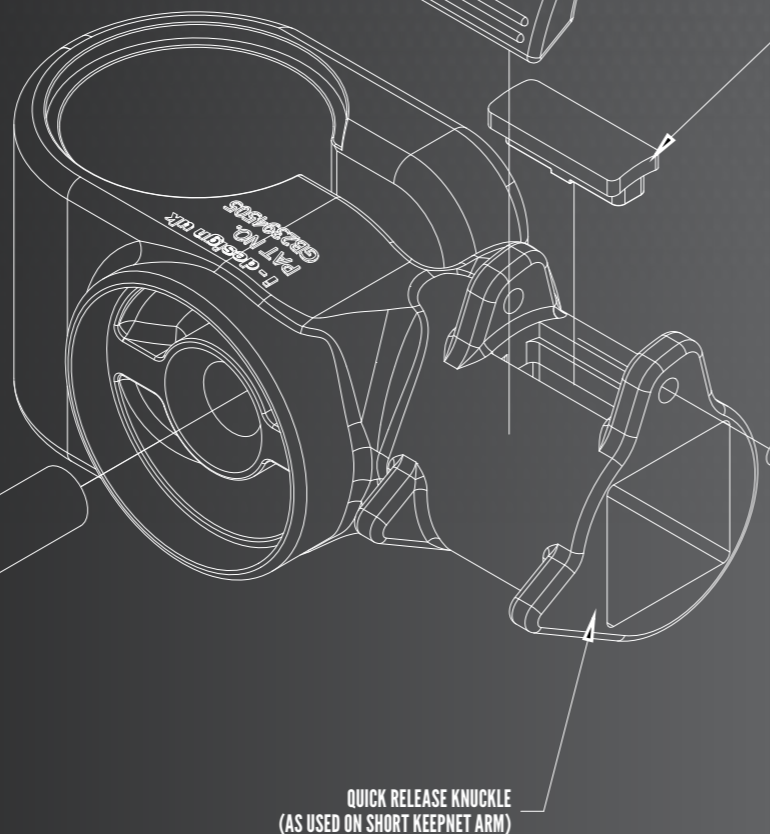
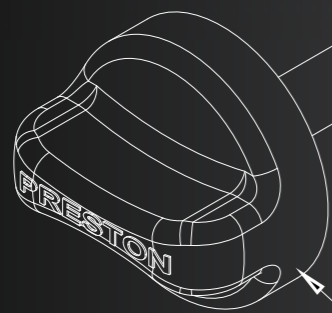

OFFBOX CAPTIVE INSERTS - NEW IMPROVED DESIGN ALLOWS THE INSERT TO BE LOCATED SECURELY WITHIN THE KNUCKLE TO AVOID DETACHING DURING ASSEMBLY OR TRANSIT. ALL OFFBOX PRO ACCESSORIES ARE STILL COMPATIBLE WITH ALL EXISTING OFFBOX INSERTS.



OFFBOX & INBOX : OFFBOX PRO

OFFBOX & INBOX : OFFBOX PRO



new

SIDE TRAY SET

A multi-functional tray set, comprising of a Super Side Tray, and a Deep Bait Tray. The side tray has location points on the underside, allowing the bait tray to be slid underneath - ideal for keeping baits and accessories dry in wet conditions.

INSERTS SUPPLIED: 25MM ROUND, 23MM ONBOX, 19MM SQUARE
DIMENSIONS: L: 430MM W: 390MM

TRADE QTY
2
CODE
OBP/27
DESCRIPTION
Side Tray Set



COMPLETE WITH TELESCOPIC LEG

new

MEGA SIDE TRAY

The double-knuckled Mega Side Tray will accommodate a wide selection of bait, groundbait and fishing tackle. Supplied with a telescopic support leg for ultimate stability.

- Super rigid construction with integral lightweight aluminium support frame
- Dual seatbox fixing points for maximum stability
- Supporting leg (included) can also be used to attach additional OffBox Pro accessories

INSERTS SUPPLIED: 25MM ROUND, 23MM ONBOX, 19MM SQUARE
DIMENSIONS: L: 600MM W: 400MM

TRADE QTY
2
CODE
OBP/29
DESCRIPTION
Mega Side Tray



new

SMALL SIDE TRAY

Durable construction and recessed profile, this is perfect for minimal bait requirements and is compact enough to fit in most carryalls.

INSERTS SUPPLIED: 25MM ROUND, 23MM ONBOX, 19MM SQUARE
DIMENSIONS: L: 370MM W: 260MM

TRADE QTY
3
CODE
OBP/24
DESCRIPTION
Small Side Tray



new

LARGE SIDE TRAY

Light yet strong and will accommodate a wide selection of baits featuring durable construction and recessed profile. Also ideal as a secondary rear side tray.

INSERTS SUPPLIED: 25MM ROUND, 23MM ONBOX, 19MM SQUARE
DIMENSIONS: L: 435MM W: 320MM

TRADE QTY
3
CODE
OBP/25
DESCRIPTION
Large Side Tray



new

SUPER SIDE TRAY

Perfect for holding a large selection of baits and accessories, featuring a moulded lip to keep everything in place whilst fishing. Angled for optimum performance.

INSERTS SUPPLIED: 25MM ROUND, 23MM ONBOX, 19MM SQUARE
DIMENSIONS: L: 430MM W: 390MM

TRADE QTY
3
CODE
OBP/26
DESCRIPTION
Super Side Tray



COMPLETE WITH 2 TELESCOPIC LEGS

EASY FIT

new

MONSTER® SIDE TRAY

The lightweight, two-piece aluminium construction makes it easy to transport and with the two supporting legs fitted creates an ultra-stable set up. The twin leg attachments can be repositioned making it suitable for any seatboxes with a leg spacing between 17cm and 75cm. Can also be used as a one piece smaller side tray with single supporting leg if required.

INSERTS SUPPLIED: 25MM ROUND, 23MM ONBOX, 19MM SQUARE
DIMENSIONS: L: 950MM W: 560MM

TRADE QTY
1
CODE
OBP/30
DESCRIPTION
Monster Side Tray



new

SNAPLOK BAIT WAITER

The shallow recesses will accept many combinations of bait tubs. Can also be fitted directly to all standard banksticks.

INSERTS SUPPLIED: 25MM ROUND, 23MM ONBOX, 19MM SQUARE
DIMENSIONS: L: 340MM W: 360MM

TRADE QTY
3
CODE
OBP/28
DESCRIPTION
Bait Waiter

2 FIVE PINT BAIT TUBS INCLUDED



new

MONSTER® EVA BAIT STATION

Complete with two 5 pint capacity bait tubs (lids not included) and zipped EVA square bowl with rigid hoop. The OffBox Pro knuckle can be attached to both seatbox and platform legs and once in position can be swivelled to the correct position. Can also be used without the bait tubs as a large groundbait bowl.

INSERTS SUPPLIED: 25MM ROUND, 23MM ONBOX, 19MM SQUARE
DIMENSIONS: L: 380MM W: 380MM

TRADE QTY
1
CODE
OBP/36
DESCRIPTION
Monster EVA Bait Station

new



*BAIT TUBS NOT INCLUDED

COMPATIBLE WITH PRESTON BAIT TUBS PAGE 59

MONSTER® EVA MEGA BAIT STATION

Based around a lightweight and strong aluminium frame with zipped rectangular EVA bowl. The OffBox Pro knuckles can be attached to either seatbox or platform legs for ultimate stability and the lid can be propped up at various angles to offer protection from the elements whilst maintaining access to bait at all times.

INSERTS SUPPLIED: 25MM ROUND, 23MM ONBOX, 19MM SQUARE
DIMENSIONS: L: 560MM W: 390MM

TRADE QTY
1
CODE
OBP/50
DESCRIPTION
Monster EVA Mega Bait Station

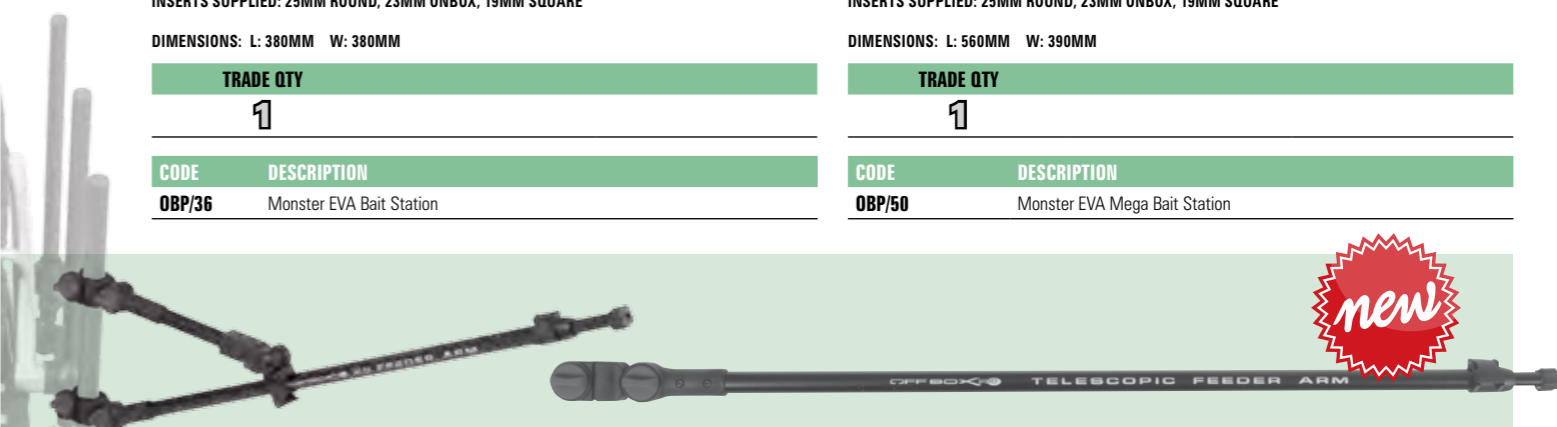

new

XS FEEDER ARM

With dual fixing points for maximum stability one or both of the XS Feeder Arm fittings can be positioned underneath the seatbox leg adjusting block offering ultimate versatility and can be quickly adjusted to any position.

INSERTS SUPPLIED: 25MM ROUND, 23MM ONBOX, 19MM SQUARE

TRADE QTY
2
CODE
OBP/22
DESCRIPTION
XS Feeder Arm

TELESCOPIC FEEDER ARM

New design offers greater stability and additional strength. The 360° infinite angle lock enables you to place your rod exactly where you want it, making the feeder arm ideal for venues where a conventional bankstick can't be used. Complete horizontal and vertical adjustment.

INSERTS SUPPLIED: 25MM ROUND, 23MM ONBOX, 19MM SQUARE

TRADE QTY
2
CODE
OBP/21
DESCRIPTION
Telescopic Feeder Arm

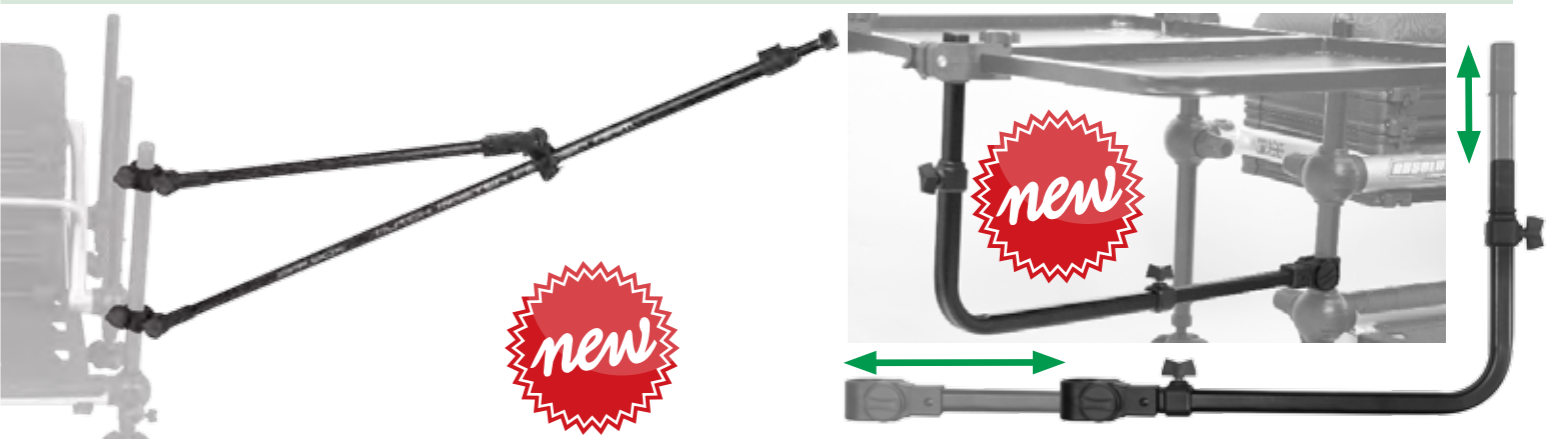

new

DUTCH MASTER FEEDER ARM

Designed with dual fixing points which enables this feeder arm to be fitted below the frame of your seatbox. Featuring an extended supporting arm, this is the most stable feeder arm we have produced, even at its 2.1m fully extended length. Ideal for using with long feeder rods and in situations where you need to keep as much line out of the flow as possible.

INSERTS SUPPLIED: 25MM ROUND, 23MM ONBOX, 19MM SQUARE

TRADE QTY
2
CODE
OBP/23
DESCRIPTION
Dutch Method Feeder Arm



new

SIDE TRAY SUPPORT ARM

Adjustable in both height and length, the Side Tray Support Arm is perfect for supporting your side tray when using a leg is impossible due to the depth of the margin or the size of the fishing platform.

INSERTS SUPPLIED: 25MM ROUND, 23MM ONBOX, 19MM SQUARE

TRADE QTY
2
CODE
OBP/20
DESCRIPTION
Side Tray Support Arm

OFFBOX & INBOX : OFFBOX PRO

OFFBOX & INBOX : OFFBOX PRO

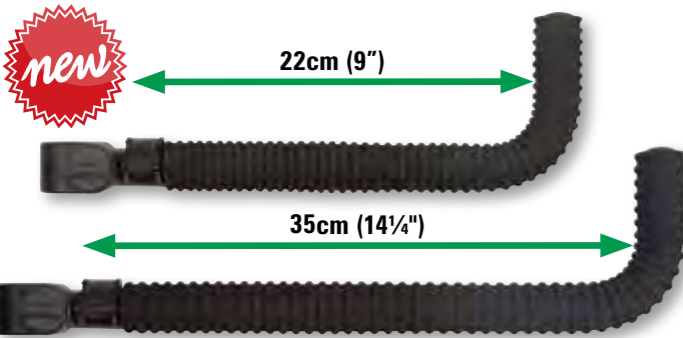

SNAPLOK
RIPPLE BARS - SINGLE

For use with rod rest heads, butt rests, pole grips and pole socks. Can be used for holding pole sections when not in use.

INSERTS SUPPLIED:
25MM ROUND, 23MM ONBOX, 19MM SQUARE

TRADE QTY	
3	
CODE	DESCRIPTION
OBP/14	Short
OBP/15	Long

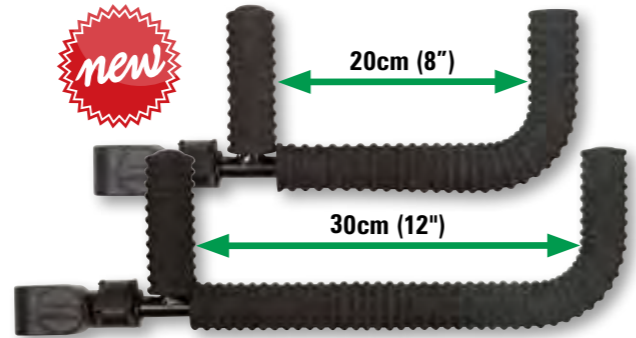

SNAPLOK
RIPPLE BARS - DOUBLE

Features two threads for attaching a multitude of accessories. Can also be used for holding pole sections when not in use.

INSERTS SUPPLIED:
25MM ROUND, 23MM ONBOX, 19MM SQUARE

TRADE QTY	
3	
CODE	DESCRIPTION
OBP/16	Short
OBP/17	Long



SNAPLOK
RIPPLE BUTT REST ARM

Ideal for resting the butt of the rod when feeder fishing, allowing perfect rod positioning every time – ensuring you don't move the feeder.

INSERTS SUPPLIED:
25MM ROUND, 23MM ONBOX, 19MM SQUARE

TRADE QTY	
3	
CODE	DESCRIPTION
OBP/18	Ripple Butt Rest Arm

ROD SUPPORT

To safely and securely hold your rod leaving your hands free for tying rigs, catapulting bait or unhooking fish.

INSERTS SUPPLIED:
25MM ROUND, 23MM ONBOX, 19MM SQUARE

TRADE QTY	
3	
CODE	DESCRIPTION
OBP/19	Rod Support



SNAPLOK
KEEPNET ARM

Can be rotated into any position, enables quick removal for weighing in. Complete with Quick Release Insert for fitting to keepnets.

INSERTS SUPPLIED:
25MM ROUND, 23MM ONBOX, 19MM SQUARE

TRADE QTY	
3	
CODE	DESCRIPTION
OBP/01	Short
OBP/02	Long



SNAPLOK
BROLLY ARM

Perfect for hard ground where locating an umbrella pole can be difficult, provides a stable solution to fit directly to the seatbox leg. Compatible with all standard umbrellas.

INSERTS SUPPLIED:
25MM ROUND, 23MM ONBOX, 19MM SQUARE

TRADE QTY	
3	
CODE	DESCRIPTION
OBP/05	Short
OBP/06	Long



SNAPLOK
UNIVERSAL ARM

Can be fixed horizontally or vertically for ultimate versatility. Complete with 125mm XL Bankstick the Universal Arm has a multitude of uses.

INSERTS SUPPLIED:
25MM ROUND, 23MM ONBOX, 19MM SQUARE

TRADE QTY	
3	
CODE	DESCRIPTION
OBP/10	Universal Arm



SNAPLOK
CROSS ARM

Angled 90° arm has a multitude of uses and comes complete with Quick Release Insert for use with keepnets, pole socks and bait waiters.

INSERTS SUPPLIED:
25MM ROUND, 23MM ONBOX, 19MM SQUARE

TRADE QTY	
3	
CODE	DESCRIPTION
OBP/03	Short
OBP/04	Long

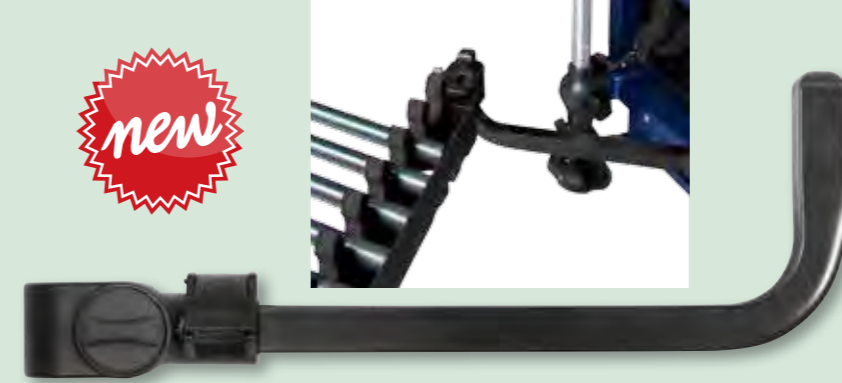

SNAPLOK
SPACER BAR

To position side trays and other accessories around the seatbox offering a more versatile set up and allowing the angler to make better use of the space in their peg.

INSERTS SUPPLIED:
25MM ROUND, 23MM ONBOX, 19MM SQUARE

TRADE QTY	
3	
CODE	DESCRIPTION
OBP/11	Spacer Bar



SNAPLOK
MULTI POLE SUPPORT

Designed to fit all popular leg and seatbox systems, the Multi Pole Support is totally height adjustable making it ideal for all pole fishing applications. The support roller is ultra-rigid when in use and has a profiled head which rolls – making pole positioning absolutely perfect. Alternatively, thanks to the ingenious Snap-Lok cam system you can substitute it for the single 'diabolo' style head which can be used fixed or free running which is ideal when pole fishing on rivers and moving water. Makes fishing at longer lengths, for long periods, much easier and leaves your hands free for feeding. Great for positioning the pole tip just above the surface when fishing shallow and constantly feeding.

INSERTS SUPPLIED: 25MM ROUND, 23MM ONBOX, 19MM SQUARE

TRADE QTY	
2	
CODE	DESCRIPTION
OBP/45	Multi Pole Support



PRO POLE SUPPORT

The ultra-stable Pro Pole Support works on the same principle as the original version and is perfect for fishing at very long range giving hands free support. This version has a clever bent configuration and longer front arms which give more clearance at the front of the foot platform, which allows easy access to keepnets and the high sides prevent the pole from being blown from the rest in windy conditions.

INSERTS SUPPLIED: 25MM ROUND, 23MM ONBOX, 19MM SQUARE

TRADE QTY	
2	
CODE	DESCRIPTION
OBP/46	Pro Pole Support

SUPPLIED WITH
PADDED
STORAGE BAG

OFFBOX & INBOX : OFFBOX PRO

OFFBOX & INBOX : OFFBOX PRO

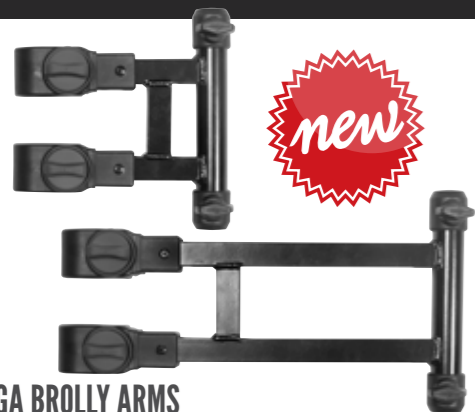

new

MEGA BROLLY ARMS

With twin knuckles for ultimate stability, they secure the umbrella to the seatbox and can be rotated to the desired position for optimum coverage.

INSERTS SUPPLIED: 25MM ROUND, 23MM ONBOX, 19MM SQUARE

TRADE QTY	
3	

CODE	DESCRIPTION
OBP/07	Short
OBP/08	Long



new

BAIT BROLLY

Height adjustable and with an additional tilt facility, it keeps bait dry and out of sunlight. Supplied with an extra-long Brolly Arm for locating over side trays for maximum protection.

DIMENSIONS: 74CM X 74CM

INSERTS SUPPLIED: 25MM ROUND, 23MM ONBOX, 19MM SQUARE

TRADE QTY	
2	

CODE	DESCRIPTION
OBP/09	Bait Brolly



new

SNAPLOK PRO TOOL BAR

With dual telescopic extensions, designed to fit across the front of your footplate and includes 3 Quick Release Accessory Blocks suitable for attaching keepnets, pole socks and other accessories.

INSERTS SUPPLIED: 25MM ROUND, 23MM ONBOX, 19MM SQUARE

TRADE QTY	
2	

CODE	DESCRIPTION
OBP/47	Pro Tool Bar

SNAPLOK QUICK RELEASE ACCESSORY BLOCK

Compatible with Tool Bars, Mega and Monster Side Trays as well as any that offer 19mm profile accessories. Can be fitted horizontally or vertically and comes complete with Quick Release Insert.

INSERTS SUPPLIED: 25MM ROUND, 23MM ONBOX, 19MM SQUARE

TRADE QTY	
3	

CODE	DESCRIPTION
OBP/48	Quick Release Accessory Block



new



new

BUCKET & BOWL SET

Comprises one 25L capacity mixing bucket with lid and a groundbait bowl and riddle. Both bucket and bowl can be attached to your seatbox with the OffBox Pro hoop support.

INSERTS SUPPLIED: 25MM ROUND, 23MM ONBOX, 19MM SQUARE

TRADE QTY	
3	

CODE	DESCRIPTION
OBP/31	Bucket & Bowl Set
OFFBOX/57	Round Riddle Only



new

GROUNDBAIT BOWL & HOOP

A plastic groundbait bowl with a rigid hoop fitted for attaching to a seatbox or platform legs.

INSERTS SUPPLIED: 25MM ROUND, 23MM ONBOX, 19MM SQUARE

TRADE QTY	
3	

CODE	DESCRIPTION
OBP/32	Small
OBP/33	Large



EVA BOWL & HOOP

A waterproof EVA groundbait bowl with a rigid hoop, for attaching to a seatbox or platform legs. Collapsible for easy storage and transportation.

INSERTS SUPPLIED: 25MM ROUND, 23MM ONBOX, 19MM SQUARE

TRADE QTY	
3	

CODE	DESCRIPTION
OBP/34	Small
OBP/35	Large



new

UP & OVER POLE REST

Use on its own as a rod or butt rest or alternatively as a pair to hold the pole whilst feeding. Soft grip pole hooks to minimise risk of pole damage.

INSERTS SUPPLIED: 25MM ROUND, 23MM ONBOX, 19MM SQUARE

TRADE QTY	
4	

CODE	DESCRIPTION
OBP/12	Up & Over Pole Rest



new

SNAPLOK BALLING IN ARM

Fully adjustable for balling in groundbait when used as a pair. Can be used singularly as a rod or pole rest. Soft grip pole hooks to minimise risk of pole damage.

INSERTS SUPPLIED: 25MM ROUND, 23MM ONBOX, 19MM SQUARE

TRADE QTY	
4	

CODE	DESCRIPTION
OBP/13	Balling In Arm



new

SNAPLOK QUICK RELEASE INSERTS

Can be used in conjunction with all OffBox Pro SnapLok attachments and are ideal for making multiple accessories OffBox Pro compatible.

2 PER PACK

TRADE QTY	
5	

CODE	DESCRIPTION
OBP/49	Quick Release Inserts



new

OFFBOX PRO SPARES

2 PER PACK

TRADE QTY

5

CODE	DESCRIPTION
OBP/51	Handwheels
OBP/52	25mm Round Insert
OBP/53	23mm OnBox Insert
OBP/54	19mm Square Insert



EVA ROLLERS

High quality pole roller that fits all standard banksticks and OffBox Pro Cross Arms and Ripple Bars. With dual rollers and integral locking nuts for precision adjustment. Made from soft pole friendly EVA.

TRADE QTY	
3	

CODE	DESCRIPTION
OBP/43	Small
OBP/44	Large



new

SNAPLOK MEGA ROOST KIT

Comprises an adjustable tripod roost and an additional roost with slotted back plate which is Pulla Bung compatible and fits to your box via two adjustable OffBox Pro SnapLok arms. The soft EVA roost heads have specially shaped grooves to reduce the chance of top kits being blown out in the wind. Padded carry case included.

INSERTS SUPPLIED: 25MM ROUND, 23MM ONBOX, 19MM SQUARE

TRADE QTY	
1	

CODE	DESCRIPTION
OBP/42	Mega Roost Kit



new

TRIPOD ROOST KIT

Provides a stable storage solution for up to 8 top kits. Supplied with one 8 section roost with SnapLok cam to fit to the seatbox leg and an independent tripod with additional 8 section roost. Complete with padded bag.

INSERTS SUPPLIED: 25MM ROUND, 23MM ONBOX, 19MM SQUARE

TRADE QTY	
2	

CODE	DESCRIPTION
OBP/41	Tripod Roost Kit

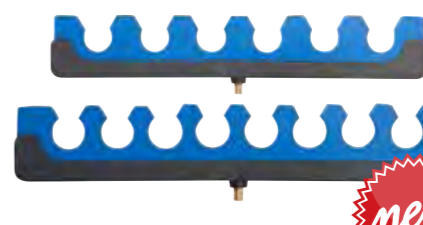

6 & 8 SECTION TOP ROOST KITS

Perfect for storing top kits safely and securely when used in conjunction with an OffBox Pro Cross Arm or Ripple Bar. Made from soft EVA with a standard screw thread, can also be fitted to a standard bankstick or tripod.

TRADE QTY	
5	

CODE	DESCRIPTION
OBP/39	6 Section
OBP/40	8 Section

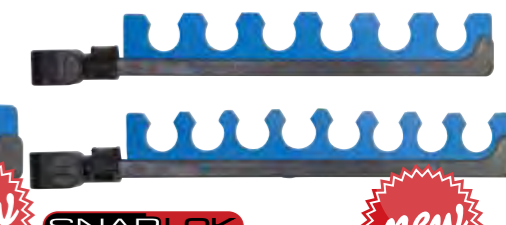

new

SNAPLOK 6 & 8 SECTION ROOSTS

Designed to ensure that top kits are stored safely and securely.

INSERTS SUPPLIED: 25MM ROUND, 23MM ONBOX, 19MM SQUARE

TRADE QTY	
3	

CODE	DESCRIPTION
OBP/37	6 Section
OBP/38	8 Section



REPLACEMENT LEGS

Fits original Onbox seatbox range, plus any other boxes with 19mm square legs.

TRADE QTY	
1 (pair)	
CODE	DESCRIPTION
ONBOX/05	19mm Square Legs (Pair) 35cm
ONBOX/06	19mm Square Legs (Pair) 45cm
ONBOX/07	19mm Square Legs (Pair) 60cm
ONBOX/08	19mm Square Legs (Pair) 90cm
ONBOX/21	19mm Telescopic Square Legs (Pair)

Fits current Space Station and XS seatbox range.

TRADE QTY	
1 (pair)	
CODE	DESCRIPTION
SPST/04	XS 23mm Square Legs (Pair) 66cm
SPST/13	XS 23mm Telescopic Square Legs (Pair) 45cm

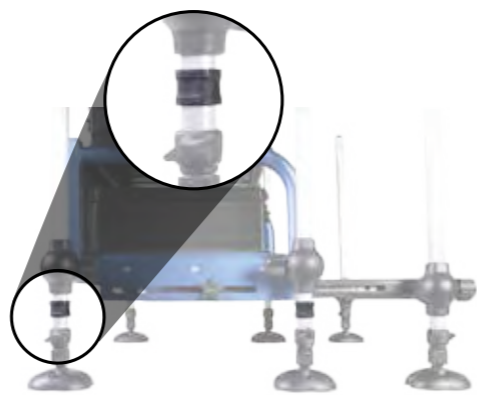

LEG LEVELLERS

Each set consists of a set of collars which make sure that your seat box starts from a level position, useful when most of your fishing is done from platforms and staging and only minor adjustments are required.

TRADE QTY	
1	
CODE	DESCRIPTION
SPST/17	Space Station With Fixed Footplates Leg Levellers
ONBOX/72	OnBox XS & Compact Station Leg Levellers

LEG EXTENDER

Suitable for all XS Space Station seatboxes and XS OnBox models, as well as the original seatbox leg systems.

TRADE QTY	
3	
CODE	DESCRIPTION
ONBOX/09	Onbox 19mm Leg Extender
ONBOX/62	XS Leg Extender



ONBOX HAND WHEELS

OFFBOX HAND WHEELS

OFFBOX INSERTS

Compatible with original OffBox accessories, NOT compatible with OffBox Pro.

TRADE QTY			
5			
CODE	DESCRIPTION	CODE	DESCRIPTION
OFFBOX/31	25mm Round Inserts	OFFBOX/35	16mm Round Inserts
OFFBOX/32	20mm Square Inserts	OFFBOX/82	19mm Square Inserts
OFFBOX/33	16mm Octagonal Inserts	OFFBOX/63	23mm Space Station Inserts

OFFBOX SPARES

A selection of spares just in case you lose any of your OffBox components.

TRADE QTY			
10			
CODE	DESCRIPTION	TRADE QTY	
OFFBOX/62	Locking Nut	5	
OFFBOX/23	Offbox - Gromit	ONBOX/34	OnBox Hand Wheels (pair)
OFFBOX/34	OffBox Hand Wheels	OFFBOX/34	OffBox Hand Wheels
ONBOX/43	Locking Peg Set	ONBOX/43	Locking Peg Set



BUTT REST

Designed to hold the rod butt securely whether fishing in either a horizontal or vertical position (due to the moulded 'lip' at the rear of the rest).

TRADE QTY	
5	
CODE	DESCRIPTION
OFFBOX/43	Butt Rest



TUBE ROD REST

The soft rubber tube insert and high sides hold your rod securely in place - even in the windiest conditions. The Tube Rest also incorporates Fixangle ensuring that the rest remains at exactly the right angle.

TRADE QTY	
5	
CODE	DESCRIPTION
OFFBOX/42	Tube Rod Rest



FREE FLOW ROD REST

High-sided rod rest on a Fixangle mechanism featuring a deep line groove allowing direct contact with your bait.

TRADE QTY	
5	
CODE	DESCRIPTION
OFFBOX/69	Free Flow Rod Rest



BLOODWORM BAIT TUB

The white tub helps selecting an individual bait easier, whilst the riddle, which fits into the tub, is ideal for removing dead bait, making cleaning your bait easier.

TRADE QTY	
10	
CODE	DESCRIPTION
PBT/2R	Bloodworm Bait Tub



QUIVER ROD REST

Special 'angle' design head enabling secure rod positioning when fishing the tip. This rod rest head comes with the Fixangle mechanism which locks the rest into the exact angle required.

TRADE QTY	
5	
CODE	DESCRIPTION
OFFBOX/41	Quiver Rod Rest

FLAT FEEDER REST

Combining the benefits of a fixed position head with the rod adjustment of a conventional Dutch style rest. The soft rubber cover 'grips' the rod when placed stationary on the rest but still allows adjustments to be made to the rod position without removing it from the rest. Complete with Fixangle adjustment.

TRADE QTY	
5	
CODE	DESCRIPTION
OFFBOX/108	Flat Feeder Rest

BAIT TUBS

These excellent Bait Tubs have internal measuring marks for bait measurement. They work well individually or as a modular unit with bait waiters.

TRADE QTY		
25		
CODE	DESCRIPTION	TRADE QTY
PBT/0.5	Pellet Tub	0.5pt / 0.3lt
PBT/1	Bait Tub	1pt / 0.6lt
PBT/2	Bait Tub	2pt / 1.2lt
PBT/3	Bait Tub	3pt / 1.8lt

TRADE QTY		
10		
CODE	DESCRIPTION	TRADE QTY
PBT/3MR	Bait Tub	3pt / 1.8lt with riddle
OFFBOX/17	Bait Tub Large	5+ pints

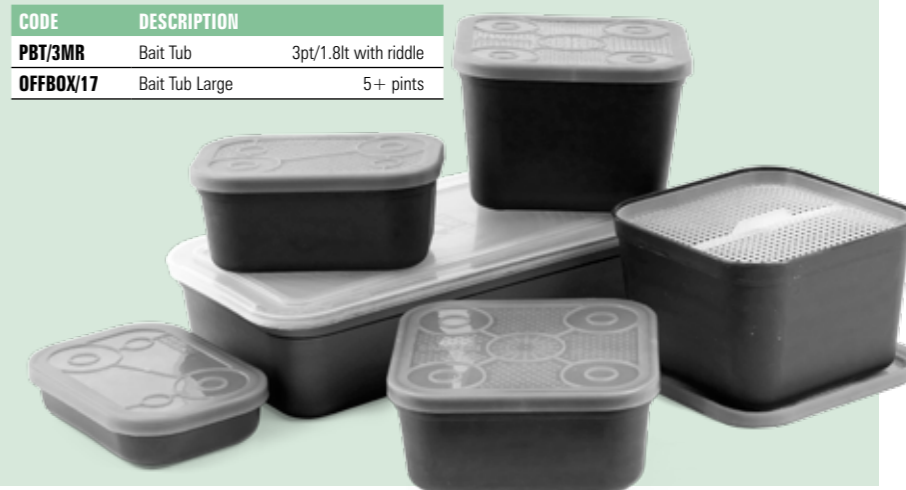



SEATBOX COVERS

Water-resistant covers for OnBox and Absolute seatboxes.

TRADE QTY	
1	
CODE	DESCRIPTION
ONBOX/87	OnBox Seatbox Cover
ABST/20	Absolute Seatbox Cover



TOTAL CONTROL POLE REST

Secures to the back legs of your seatbox providing an invaluable 'third hand'. Supports your pole leaving your hands free, perfect for feeding. Helps to secure your pole when fishing in bad weather conditions. Takes the weight when shipping back the first few meters whilst fishing long.

Helping to make the whole shipping process much smoother.

TRADE QTY	
2	
CODE	DESCRIPTION
OFFBOX/96	Total Control Pole Rest



POLE SOCK

Perfect for keeping your pole close to hand and preventing it sliding forwards. It has a band around the neck to make location easy and prevent snagging. Fitted with a standard thread to fit onto a bank stick or OffBox accessories.

TRADE QTY	
5	
CODE	DESCRIPTION
PSOCK	Pole Sock



POLE GRIP

Holds your pole close to hand. Gently sprung plastic sides grip pole sections from 3-6. Use with either a standard bankstick or one of several OffBox attachments.

TRADE QTY	
6	
CODE	DESCRIPTION
OFFBOX/87	Pole Grip



THREADED INSERT



XL BANKSTICKS

Compatible with OffBox accessories, the XL Banksticks feature the 30mm Absolute profile and provide an ultra stable solution to attaching keepnets, rod rests and other seat box accessories.

AVAILABLE IN 125MM AND 250MM

TRADE QTY	
5	
CODE	DESCRIPTION
OFFBOX/102	125mm XL Banksticks
OFFBOX/103	250mm XL Banksticks

PRO ROOST KIT

Designed to take up to eight top kits, the Pro Roost Kit works from one leg of your box and can be assembled in seconds. Also included are a range of inserts and a compact padded carry bag.

TRADE QTY	
2	
CODE	DESCRIPTION
OFFBOX/63	Pro Roost Kit



SHORT DUTCH FEEDER REST

Designed to offer excellent flexibility when placing the rod. The fully padded arm protects the rod from damage. Perfect for carp feeder fishing as the rod can move freely along the rest on the bite.

TRADE QTY	
3	
CODE	DESCRIPTION
OFFBOX/70	Short Dutch Feeder Rest



ANGLE LOCK

Designed to be screwed into a bankstick or an OffBox arm, with a robust locking mechanism to take any accessory with a standard thread and make it adjustable.

TRADE QTY	
5	
CODE	DESCRIPTION
OFFBOX/74	Angle Lock



FIXED ANGLE LOCK

Designed to fit between a feeder arm and feeder rest, providing the angler with an ultra stable, positive set up.

TRADE QTY	
5	
CODE	DESCRIPTION
OFFBOX/107	Fixed Angle Lock



DUTCH MASTER FEEDER BANKSTICK

Can be pushed into the bank, allowing you to have your rest over the water and enabling you to sink your line as normal. It offers super-stable performance combined with unlimited adjustability.

TRADE QTY	
2	
CODE	DESCRIPTION
OFFBOX/99	Dutch Master Feeder Bankstick



DELUXE DUTCH FEEDER REST

The deluxe version features rippled foam for perfect rod placement and comes complete with our new Fixed Angle Lock for precision adjustment. Essential for all serious feeder anglers.

TRADE QTY	
3	
CODE	DESCRIPTION
OFFBOX/105	Short
OFFBOX/106	Standard

METHOD FEEDER REST

Features a fully padded arm to protect the rod and guides from damage. Shape allows the rod to move freely along the rest on the bite whilst the curved end prevents the rod from being pulled off by an aggressive take.

TRADE QTY	
5	
CODE	DESCRIPTION
OFFBOX/88	Method Feeder Rest

A RANGE OF ROLLERS AND TRIPODS OFFERING SUPERB CHOICE



PRO TRIPOD

Lightweight and very stable, the Pro Tripod can take all screw fitting attachments like rod rest heads, pole rollers and pole roosts. Perfect for hard canal and man-made fishery banks. Comes supplied in a carrycase.

TRADE QTY	
2	
CODE	DESCRIPTION
TPOD/01	Pro Tripod
TPOD/02	Pro XL Tripod



PRO V ROLLER

The UK's best selling V pole roller! Based on an ultra lightweight tripod, this roller has been a huge success since its launch. Not only does it have height adjustable features, it also has the added advantage of being able to alter the angle at which the legs are set, making any type of bankside terrain easy to cope with.

The braced tripod assembly locks securely and has drop-down leg extensions which are locked at the required height by quick release clasps. The height adjustable centre pole also locks with its own handwheel.

TRADE QTY	
2	
CODE	DESCRIPTION
PVROL	Pro V Roller

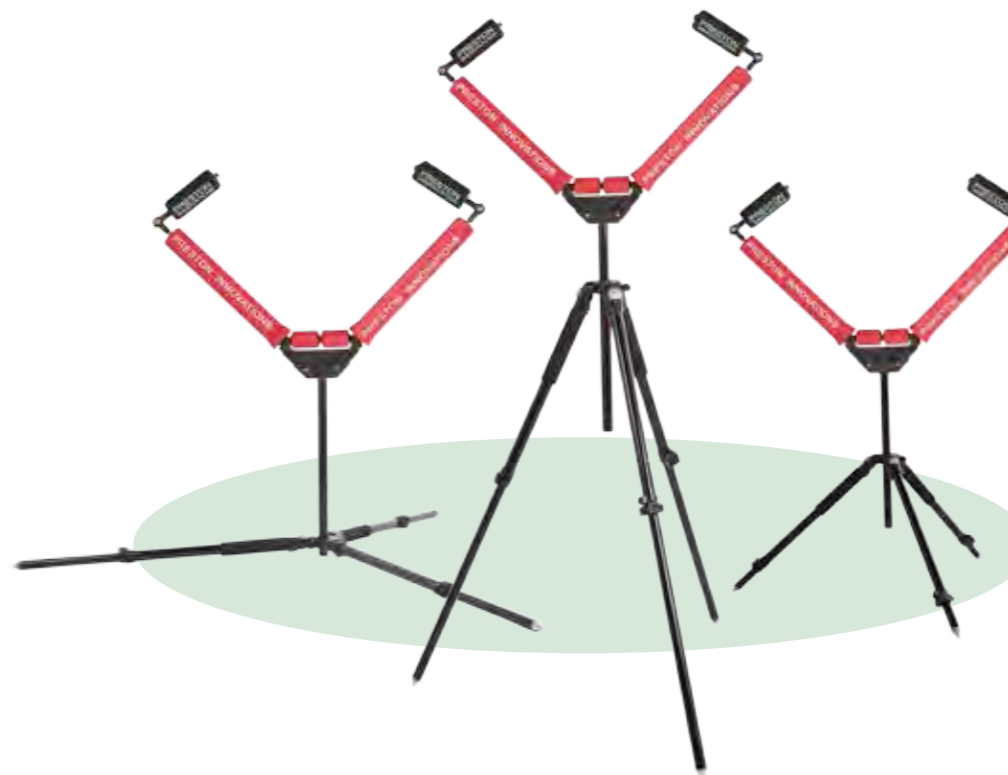

MEGA PRO V ROLLER

The Mega Pro V Roller is the highest quality roller we have ever produced. The ultra sturdy tripod features legs that can be laid out flat, providing the most stable set up possible. With its range of height adjustments it can also be set high enough to navigate over any tall obstacles. Featuring the same rollers as used on the Super Pro V, with its centre roller made in two parts, perfect for situations where you need to break down twice. This top class roller is also supplied with the innovative new roller stops as standard. These clever little attachments are fitted to the end of each of the side rollers, stopping the pole from blowing out in windy conditions.

TRADE QTY	
1	
CODE	DESCRIPTION
PVMROL	Mega Pro V Roller

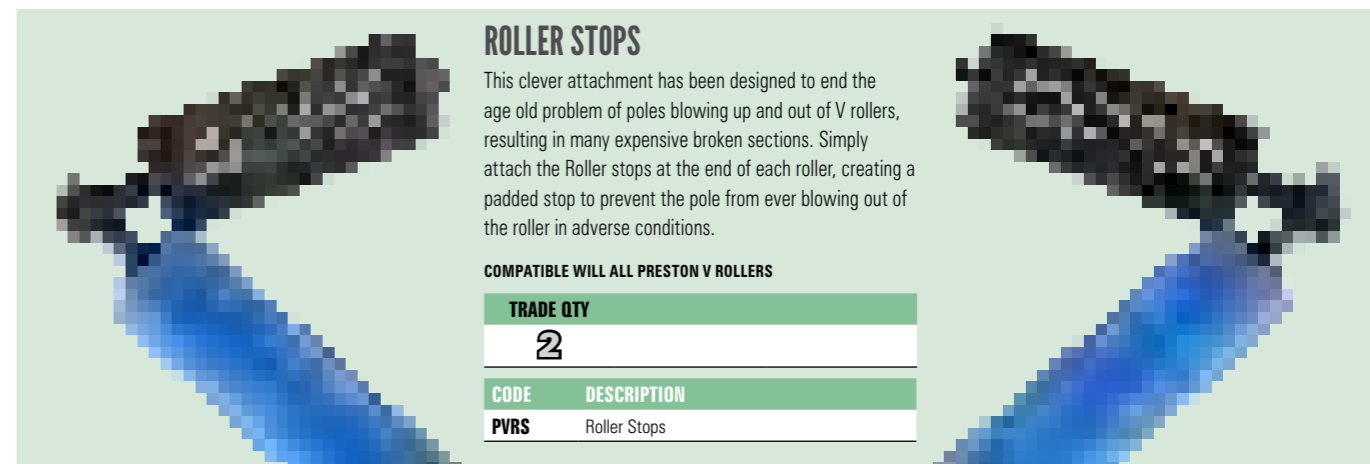

ROLLER STOPS

This clever attachment has been designed to end the age old problem of poles blowing up and out of V rollers, resulting in many expensive broken sections. Simply attach the Roller stops at the end of each roller, creating a padded stop to prevent the pole from ever blowing out of the roller in adverse conditions.

COMPATIBLE WILL ALL PRESTON V ROLLERS

TRADE QTY	
2	
CODE	DESCRIPTION
PVRS	Roller Stops



WHETHER YOU CHOOSE A FLAT ROLLER OR A TRIPOD STYLE THE PRESTON INNOVATIONS RANGE OFFERS THE BEST OF BOTH WORLDS

SUPER PRO V ROLLER

Based on the popular Pro V Roller, there are several key differences on the Super version. An extra set of internal legs enable the roller to be set higher than before. To prevent overbalancing the base of the centre section has a clip suitable for attaching a groundbait bucket or carryall making the roller more stable. The centre roller is now made in two parts to make unshipping and breaking down twice as easy. The Super Pro V Roller still packs away in its own compact padded carry case.

TRADE QTY	
2	
CODE	DESCRIPTION
PVSROL	Super Pro V Roller



PRO FLAT ROLLER FOLDS DOWN TO A MANAGEABLE SIZE FOR EASY STORAGE

PRO FLAT ROLLER

Featuring a rapid assembly design, these lightweight flat rollers come with their own compact padded bag for ease of carrying. The standard roller offers a large 500mm wide bed for positive pole location and the XL version has a width of 700mm. The adjustable legs have a maximum height of 500mm on the standard version and 700mm on the XL which will clear most bankside obstructions whilst offering a stable base.

TRADE QTY	
2	
CODE	DESCRIPTION
PFRROL	Pro Flat Roller
PFXLROL	XL Pro Flat Roller

GO LARGE



WITH THE POPULARITY OF THE HOOKLENGTH RETAINING SYSTEM IT WAS INEVITABLE THAT IT WOULD EVOLVE TO ACCOMMODATE LONGER HOOKLENGTHS FOR CONVENTIONAL FEEDER FISHING. DESIGNED IN CONJUNCTION WITH MEMBERS OF THE PRESTON INNOVATIONS ENGLAND FEEDER TEAM THERE ARE NOW TWO DIFFERENT STORAGE SOLUTIONS TO STORE ANY LENGTH OF TRACE.

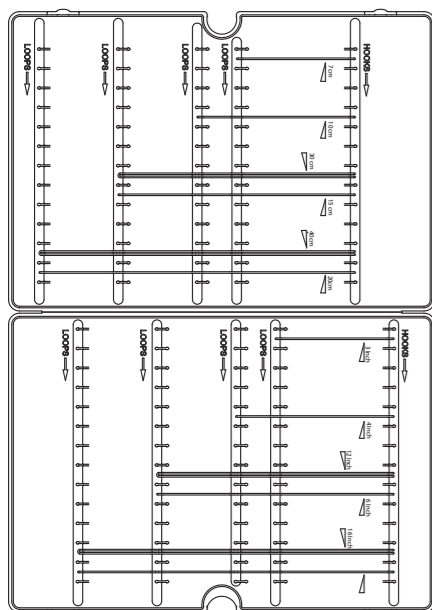

ALL-ROUND HOOKLENGTH RETAINING SYSTEM

With pins at 7.5cm (3"), 10cm (4"), 15cm (6") and 20cm (8") it can hold hooklengths for virtually all situations that you are ever likely to encounter. There is additional space at the 'hook end' to allow for any hair rigs, bands and Quick Stops that may be used.

Designed to specifically fit into the side drawers found on the Space Station and OnBox seatboxes, whilst also being compact enough to fit neatly into carryalls and bait bags.

TRADE QTY

5

CODE DESCRIPTION

INBOX/19 All-Round Hooklength System



HOOKLENGTH SPOOL SYSTEM

Offering a compact solution to storing various trace lengths the Hooklength Spool System provides the angler with unlimited permutations. Purpose designed removable spools allow different length hooklengths to be stored with minimal fuss. Designed to fit the deep compartmented drawer of our seatbox range.

- Will accommodate any length of hooklength
- Spool labels to record rig details
- Line friendly sliding loop clip
- Protective case
- Complete with 8 spools

TRADE QTY

4

CODE DESCRIPTION

INBOX/22 Hooklength Spool System

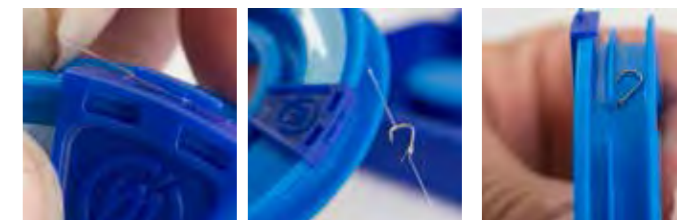
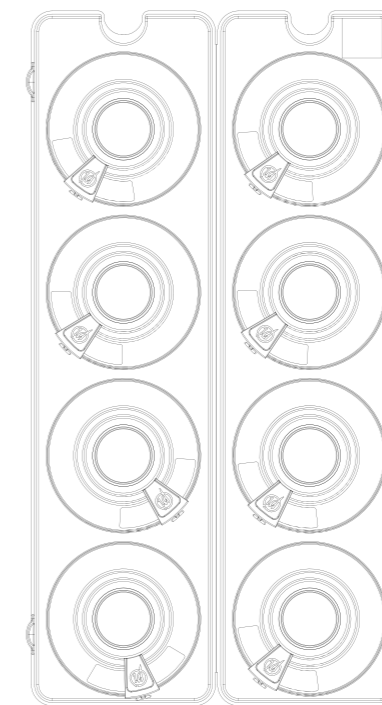

FEEDER HOOKLENGTH SYSTEM

Designed in conjunction with the Preston Innovations England Feeder Team to provide the ultimate feeder fishing hooklength storage system and will accommodate all your feeder hooklengths up to 1 metre in length.

The robust hinged construction provides strength and protection for your hooks and its magnetised release system means there are no catches to rust or fail.

It features 20 location points which will accommodate up to 200 hooks and the unique curved pegs will minimise line kinking. The built in measure allows for accurate tying of 50cm, 60cm, 75cm and 100cm hooklengths.

TRADE QTY

2

CODE DESCRIPTION

INBOX/21 Feeder Hooklength System

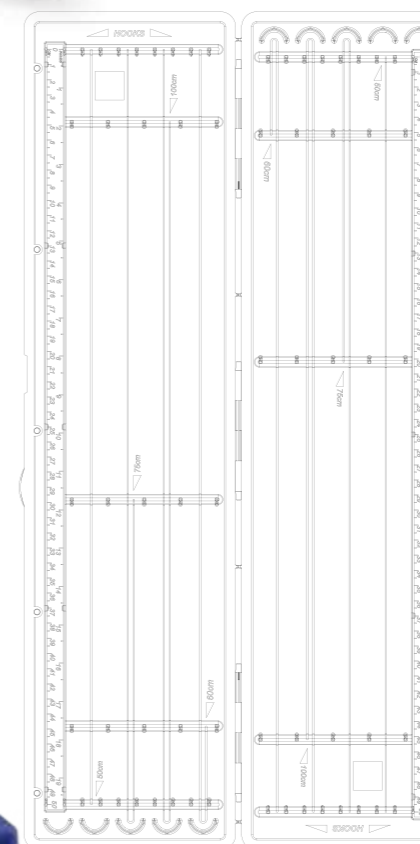

OFFBOX & INBOX : HOOKLENGTH BOXES

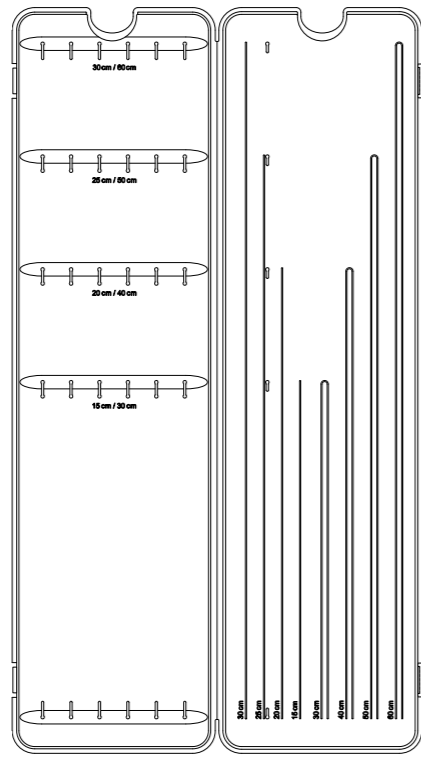
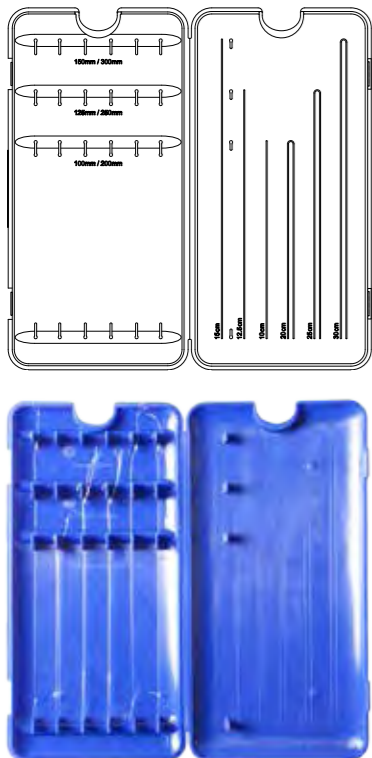

HOOKLENGTH RETAINING SYSTEM

Designed to store and protect pre-tied hooks and hook lengths. The ultra slim design can be stored in a drawer, under the seat or in the main compartment of a seatbox.

The Large version is designed to retain six different sizes of hooks/hooklength strengths, in lengths from 15cm (6") up to 60cm (24"). Available in Small or Large.



TRADE QTY	
5	
CODE	DESCRIPTION
INBOX/11	Small
INBOX/12	Large

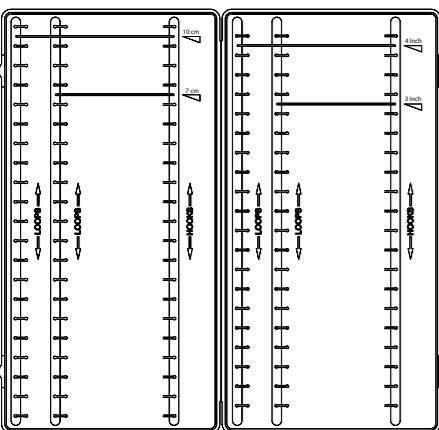

METHOD HOOKLENGTH RETAINING SYSTEM

The Method rig box is the ideal solution for carrying literally hundreds of short hooklengths, perfect for method feeder fishing.

With pins at both 7.5cm (3") and 10cm (4"), it will hold the most popular lengths used for this style of fishing.

Once again, there is enough space at the 'hook end' to accommodate hair rigs with bands, Quick Stops or standard loops.

TRADE QTY	
5	
CODE	DESCRIPTION
INBOX/20	Method Hooklength System

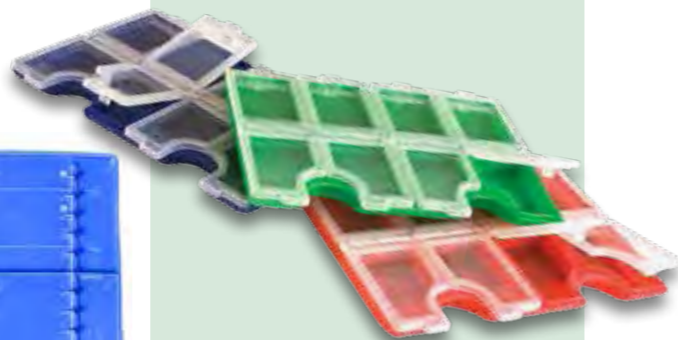

8 COMPARTMENT MAGNETIC HOOK BOXES

Have a strong magnet hidden in the base that holds your hooks securely and a smooth curved base to make their removal easy. Because the hooks never touch the magnet, corrosion is greatly reduced if the hooks get damp. The lids open individually and are waterproof. Each is colour-coded for easy recognition.

TRADE QTY	
9	
CODE	DESCRIPTION
PMHB	8 Compartment Magnetic Hook Box



DOUBLE SLIDER WINDERS

Each Double Winder features two sliders so two rigs can be neatly stored on each winder. There is a slot for your hook and a peg which would hold a loop, meaning that rigs can be tied and hooklengths added at a later date if needed – without kinking your line. The sliding anchor can be moved along the full length of the winder. There is a small retaining spike at both ends of the slider so it doesn't matter which way you wind your rig on. The tapered 'V' hook holding slot can accommodate hooks as small as size 26 without damage.

TRADE QTY		
5		
CODE	DESCRIPTION	
PDSW/13	13cm Yellow	10 PER PACK
PDSW/18	18cm Red	10 PER PACK
PDSW/20	20cm Green	10 PER PACK
PDSW/22	22cm Blue	10 PER PACK
PDSW/26	26cm Orange	10 PER PACK
PDSW/26W	26cm Wide Purple	10 PER PACK



INBOX DOUBLE WINDER BOXES

The InBox Winder Boxes fit in the shallow side drawers of the OnBox range enabling different rigs to be interchanged depending on requirements.

AVAILABLE WITH THREE SIZES OF WINDER 13CM, 18CM AND 26CM NARROW

TRADE QTY	
5	
CODE	DESCRIPTION
PDSWB/13	13cm Yellow Winders In a Box
PDSWB/18	18cm Red Winders In a Box
PDSWB/26	26cm Orange Winders In a Box



INBOX WINDER TRAYS

Open trays filled with Double Slider Winders which fit in the drawers and units of OnBox seatboxes.

TRADE QTY		
5		
CODE	DESCRIPTION	
PDSWT/13	13cm Yellow + InBox Winder Tray	20 PER PACK
PDSWT/18	18cm Red + InBox Winder Tray	14 PER PACK
PDSWT/26	26cm Orange + InBox Winder Tray	9 PER PACK
PDSWT/26W	26cm Wide Purple + InBox Winder Tray	7 PER PACK

ELASTICATION : ELASTIC

HOLLO ELASTIC

Using the highest quality materials and made to the strictest quality standards, results in trouble-free, consistent performance. Available in six different strengths to suit all carp fishing situations from 9 up to a very powerful 19. Thoroughly tested by our consultants, Hollo Elastic comes in 3m lengths in a sealed bag that ensures it stays in perfect condition. The ratings correspond to normal elastic ratings, so a 13 rating is between 12 and 14 normal elastic strength. Due to a special manufacturing process, injecting lubricant inside the elastic is not required.

TRADE QTY			
5			
CODE	DESCRIPTION	GRADE	COLOUR
HEL09	Hollo Size 9	8 - 10	Light Blue
HEL11	Hollo Size 11	10 - 12	Red
HEL13	Hollo Size 13	12 - 14	Green
HEL15	Hollo Size 15	14 - 16	Dark Blue
HEL17	Hollo Size 17	16 - 18	Yellow
HEL19	Hollo Size 19	18 - 20	Purple



FLUORO SLIP ELASTIC

Produced from pure latex combined with special fluorescent pigments that don't affect its strength or performance. Available in 10 strengths, on 5 metre spools.

TRADE QTY		
10		
CODE	DESCRIPTION	DIA
ELF02	Fluoro Size 2	0.65mm
ELF03	Fluoro Size 3	0.75mm
ELF04	Fluoro Size 4	0.87mm
ELF05	Fluoro Size 5	0.98mm
ELF06	Fluoro Size 6	1.15mm
ELF08	Fluoro Size 8	1.30mm
ELF10	Fluoro Size 10	1.45mm
ELF12	Fluoro Size 12	1.65mm
ELF14	Fluoro Size 14	1.85mm
ELF16	Fluoro Size 16	2.00mm

SLIP NATURAL LATEX ELASTIC

This high quality pure latex is sized in both diameter and numbers. Supplied on 5 metre spools, this elastic has a super smooth surface and consistent stretch to give the ultimate performance and reduce the number of lost fish.

TRADE QTY		
10		
CODE	DESCRIPTION	DIA
ENL04	Natural Size 4	0.85mm
ENL05	Natural Size 5	0.91mm
ENL06	Natural Size 6	1.06mm
ENL08	Natural Size 8	1.27mm
ENL10	Natural Size 10	1.4mm
ENL12	Natural Size 12	1.6mm
ENL14	Natural Size 14	1.8mm
ENL16	Natural Size 16	2.0mm

DOUBLE ELASTIC

This Double Elastic has been developed to make the threading of the popular Double Elastic system as easy as threading single strands. Once threaded, the strands can be easily separated resulting in perfectly fitted double elastic.

TRADE QTY		
5		
CODE	DESCRIPTION	DIA
ELD04	Double Size 4	0.85mm
ELD05	Double Size 5	0.91mm
ELD06	Double Size 6	1.06mm
ELD08	Double Size 8	1.27mm

SLIP ELASTIC

Pre-treated with Preston Slip lubricant to give outstanding abrasion resistance and reliability it is available in 5 metre lengths from ultra fine size 2 up to a powerful 16.

TRADE QTY			
10			
CODE	DESC.	DIA	COLOUR
EL02	Size 2	0.67mm	Red
EL03	Size 3	0.75mm	Green
EL04	Size 4	0.85mm	Orange
EL05	Size 5	0.91mm	Blue
EL06	Size 6	1.06mm	Yellow
EL08	Size 8	1.25mm	Black
EL10	Size 10	1.4mm	Blue
EL12	Size 12	1.6mm	Green
EL14	Size 14	1.8mm	Purple
EL16	Size 16	2.0mm	Yellow



DURA HOLLO ELASTIC SYSTEM

DURA HOLLO ELASTIC

Manufactured to exacting standards using an upgraded core material, Dura Hollo Elastic boasts increased wear resistance which is ideal for warmer conditions and offers super smooth performance in a range of six sizes to suit a wide variety of fishing situations.



TRADE QTY		
5		
CODE	DESCRIPTION	Colour
HELD08	Size 8	Blue
HELD10	Size 10	Green
HELD12	Size 12	Purple
HELD14	Size 14	Dark Blue
HELD16	Size 16	Yellow
HELD18	Size 18	Black



ELASTICATION : ELASTIC



HOLLO ELASTIC PROTECTORS

For avoiding damage to elastic when folded away. Colour-coded to match our Hollo Elastic.

6 PER PACK

TRADE QTY	
10	
CODE	DESCRIPTION
PHEP01	Size 9, Size 11, Size 13
PHEP02	Size 15, Size 17, Size 19





ROLLER PULLA

SIDE ENTRY PTFE BUSH WHICH FEATURES AN INTEGRATED PTFE ROLLER FOR ULTRA-SMOOTH FLOW OF ELASTIC THROUGH YOUR KIT WHEN PLAYING FISH

ROLLER PULLA KIT ONE

PRO TYPE COMPATIBLE

A larger diameter power top 2 kit rated to 16 elastic pre-fitted with the Roller Pulla System. Compatible with our Pro-Type poles but also featuring a long re-enforced section enabling it to be cut down to suit many other poles on the market which have larger diameter top kits.

INTERNAL DIAMETER: 22MM

TRADE QTY	
1	
CODE	DESCRIPTION
PROT/RP	Roller Pulla Kit One

ROLLER PULLA KIT TWO

GIS COMPATIBLE

High quality power top two kit rated to 16 elastic, pre fitted with the free flowing Roller Pulla System which will fit straight on to our GIS and GXR poles as well as many other top brands as the extended re-enforcement allows for cutting back to achieve a perfect fit.

INTERNAL DIAMETER: 18MM

TRADE QTY	
1	
CODE	DESCRIPTION
GIS/RP	Roller Pulla Kit Two

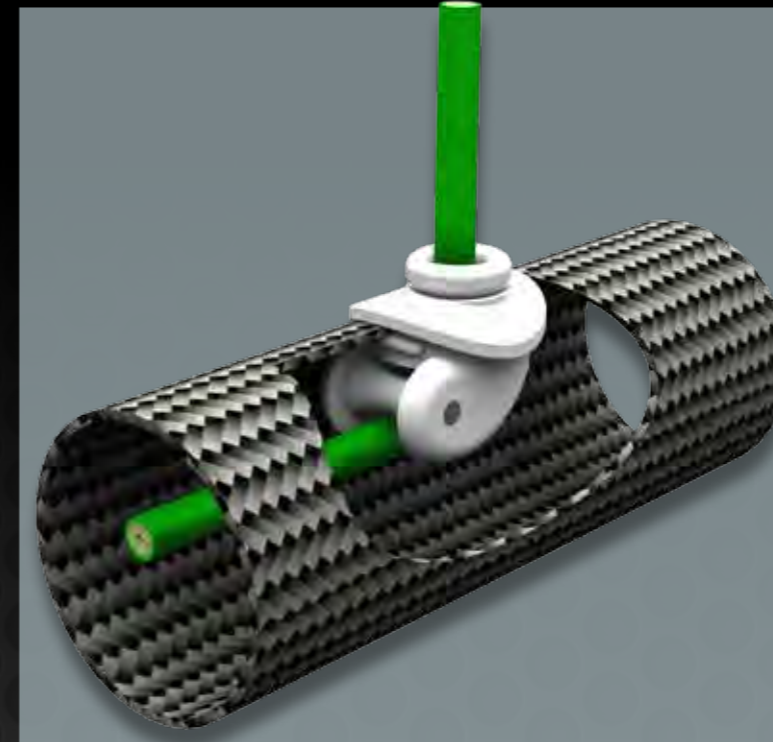

ROLLER PULLA BUSH

If neither of the kits in the range suit your pole or you already have existing kits you would like to convert the Roller Pulla System is available separately, which when fitted to a re-enforced area of the pole allows you to place the bush accurately to suit how you fish. We recommend that you seek the professional fitting that is available from many tackle shops or pole repairers.

TRADE QTY	
6	
CODE	DESCRIPTION
RPBUSH	Roller Pulla Bush

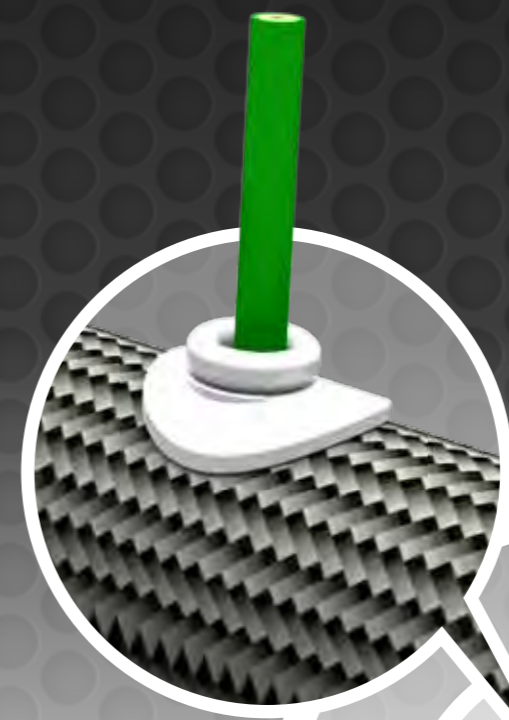

new

ROLLER DRILLA KIT

Contains the right size tools to allow the easy installation of the Roller Pulla Kit into any reinforced top kit. Full instructions overleaf show just how simply you can upgrade your top kits to Roller Pulla Kits.

TRADE QTY	
5	
CODE	DESCRIPTION
RDPK	Roller Drilla Kit

ROLLER



PULLAKIT

PRESTON INNOVATIONS



1

ROLLER



PULLAKIT

PRESTON INNOVATIONS

NEW LOOK

2

EACH KIT IS REINFORCED AND CAN BE CUT BACK TO FIT A WIDE RANGE OF POLES

COMPATIBLE WITH MAVER, DAIWA, MAP, SENSAS AND MANY MORE

STORA BUNGS

Midi Stora Bungs are designed to fit most number 2 sections whilst the larger Maxi Stora Bungs fit most number 3 sections or power number 2 kits. Both can be easily cut back to suit different diameter top kit sections. Each lightweight bung features a winder that holds spare elastic making adjustment of elastic tension quick and easy. Available in twin packs or as a single bung with an extractor rod. Extractor rods are available separately.



MEGA STORA BUNG

Designed to be used with Hollo elastics or heavy solid elastic, the Mega Stora Bung features a large winder which allows adjustments to be made by simply removing the bung and winding elastic on, or off, the bung winder. Manufactured from lightweight plastic, the Mega Stora Bung can be easily cut to fit most top kits by following score lines around the coned part. Available as a twin pack or as a single bung with an extractor rod.



TRADE QTY	
10	
CODE	DESCRIPTION
BUNG10	2 Bungs - Maxi
BUNG11	2 Bungs - Midi
BUNG12	1 Bung & 1 Extractor - Maxi
BUNG13	1 Bung & 1 Extractor - Midi
BUNG14	2 Extractors

TRADE QTY	
10	
CODE	DESCRIPTION
HBUNG01	Bung - 2 Per Pack
HBUNG02	Bung & Extractor



HOLLO CONNECTORS

Colour coded to match Hollo Elastic and made from ultra strong moulded plastic, these large connectors are designed for all hollow and large size solid elastics. A snap fit on the sliding collar ensures security.

TRADE QTY	
10	
CODE	COLOUR
HCONBS	Blue
HCONGS	Green
HCONOS	Orange
HCONYS	Yellow



SLIP EXTREME

FOR UP TO NUMBER 6 ELASTIC
Slip Extreme Connectors are similar to Preston Slip Connectors but have an almost fluorescent colour. Available in four different colours the Micro Extreme Connector is designed for elastics up to size 6.

TRADE QTY	
10	
CODE	COLOUR
MXCONGS	Green
MXCONOS	Orange
MXCONRS	Fluoro Red



SLIP MICRO CONNECTORS

FOR UP TO NUMBER 8 ELASTIC
Manufactured to micro tolerances to ensure a perfect secure fit, the Slip Micro Connectors are suitable for elastics up to a grade 8. Supplied with two sleeves, each with a different size of hole to ensure a perfect fit no matter what grade of elastic is being used.

TRADE QTY	
10	
CODE	COLOUR
MCONGS	Green
MCONOS	Orange
MCONRS	Red
MCONYS	Yellow



DEEP WATER PULLA BUNG KIT

PACKAGE CONSISTS OF:
 ■ Deep Water Pulla Bung
 ■ 4m of Power Gum
 ■ Hollo Connector
 ■ Rubber Bead
 ■ Cross Lock Rod
 Specifically for deeper venues where a top 4 kit or more is required. It has been sized to fit all sections from 4 to 6. To be used in conjunction with the Pulla Bung, this new version features a tapered lead in to allow for a Hollo connector to easily pass through it.

PULLA BUNG

Manufactured from lightweight plastic, this enables you to adjust the tension of your elastic after breaking down to the top kit. You can use lighter elastics for small carp, but tighten it for netting if you hook a bonus fish. This means you don't need to play and net big carp on top 5s or 6s, resulting in better control, faster netting and less pole breakages.

TRADE QTY	
10	
CODE	DESCRIPTION
BUNG15	Pulla Bung

STORA PULLA BUNG SYSTEM

All the advantages of a Pulla Bung whilst still being able to adjust the tension of your elastic without having to retie. Twin pack also available.

TRADE QTY	
10	
CODE	DESCRIPTION
BUNG17	Pulla Stora Bung
BUNG18	Pulla Bung Winders (Twin pack)

TRADE QTY	
5	
CODE	DESCRIPTION
BUNG16	Deep Water Pulla Bung Kit



SLIP EXTRA CONNECTORS

FOR ALL STRONG ELASTIC
Having an almost fluorescent colour making them highly visible when playing fish, the Carp Connector Extra are ultra strong and suitable for all strong elastics. Available in four different colours.

TRADE QTY	
10	
CODE	Colour
CXCONGS	Green
CXCONOS	Orange
CXCONRS	Fluoro Red
CXCONYS	Yellow



SLIP CARP CONNECTORS

FOR ELASTIC SIZES 6 AND ABOVE
Slip Carp Connectors are supplied as standard with two sleeve, each with different sized holes, to ensure a perfect fit with the elastic being used. These strong connectors are available in four colour options that match Slip Elastic.

TRADE QTY	
10	
CODE	COLOUR
BCONGS	Green
BCONOS	Orange
BCONRS	Red
BCONYS	Yellow



DACRON CONNECTORS

These Dacron connectors have been specifically developed to provide a neat link between your elastic and your rig. The Dacron holds your rig away from your pole tips whilst the purpose designed bead makes sure the Dacron points forwards to keep tangles to an absolute minimum. Now available in 6 sizes to suit all popular elastics from a fine solid latex grade 3 or 4, through to a powerful Hollo 19.

3 PER PACK

TRADE QTY		
10		
CODE	DESCRIPTION	COLOUR
DCONMCR	Micro	Red
DCONSY	Small	Yellow
DCONMDG	Medium	Green
DCONLO	Large	Orange
DCONXLB	Extra Large	Blue
DCONMGP	Mega	Purple



SPARE BEADS

Replacement beads for Pulla Kits and Pulla Bungs.

TRADE QTY	
10	
CODE	DESCRIPTION
BUNG19	Pulla Bung Spare Beads



SLIP LUBRICANT

The thin liquid adheres to the elastic to form an ultra fine film that ensures smooth elastic performance.

TRADE QTY	
5	
CODE	DESCRIPTION
SLUB14	14ml Slip Lubricant



DIAMOND EYE THREADER

Designed with a diamond shaped eye that grips the elastic. Available in extra long (2.1m) for long top twos.

TRADE QTY	
10	
CODE	DESCRIPTION
DEYEX	Diamond Eye Extra Long 2.1m





HOLLO PTFE BUSH

Made from PTFE, the Hollo Bush provides maximum performance when used with all hollow elastics. Designed to fit all power kit tops, the wide diameter ensures elastic is released smoothly. They can also be used directly on match number 2 sections. The tapered rear of the bush prevents unnecessary tangles.

TRADE QTY		
10		
CODE	DESCRIPTION	COLOUR
HEXT1	Hollo PTFE Bush	Black



STRETCH SLIP BUSH EXTERNAL

Designed for strong elastics, the Slip Stretch Bush has a thin walled construction that can be stretched to fit externally over a number 2 section.

TRADE QTY		
10		
CODE	DESCRIPTION	COLOUR
STS1S	Stretch Bush External	Yellow
STS2S	Stretch Bush External	Orange

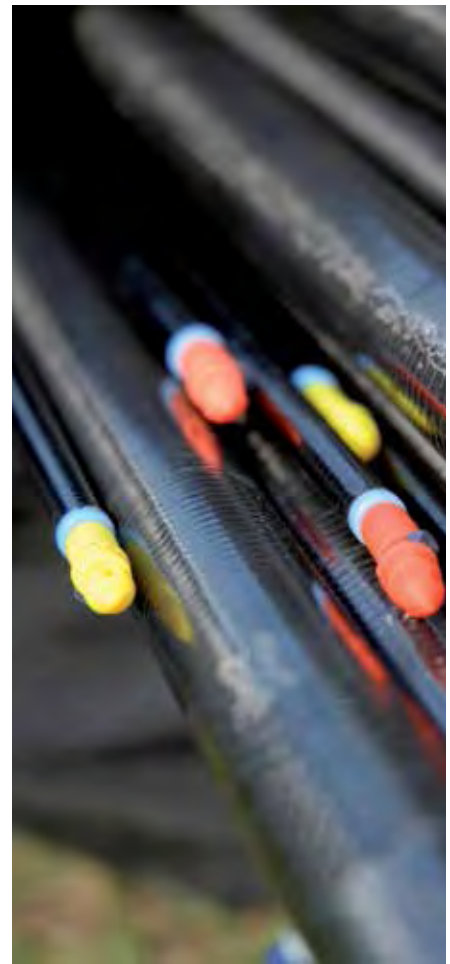

XLARGE INTERNAL SLIP BUSH

Designed to fit internally into the number 2 section of match kits, or wide bore power kits.

TRADE QTY		
10		
CODE	DESCRIPTION	COLOUR
SINX00S	XL Internal Bush Size 2.6mm	White
SINX0S	XL Internal Bush Size 2.8mm	White
SINX1S	XL Internal Bush Size 3.0mm	Blue
SINX2S	XL Internal Bush Size 3.5mm	Red
SINX3S	XL Internal Bush Size 3.8mm	White



SLIP INTERNAL PTFE BUSH

Designed to fit inside the pole tip, the Slip Internal Bush is made from PTFE for friction-free performance. The small shoulder fits neatly to the end of the pole and the internal section, whilst the strong construction makes fitting easy.

TRADE QTY		
10		
CODE	DESCRIPTION	COLOUR
SIN1S	Slip Bush Internal	Purple
SIN2S	Slip Bush Internal	Red
SIN3S	Slip Bush Internal	Green
SIN4S	Slip Bush Internal	Orange
SIN5S	Slip Bush Internal	Yellow



SLIP EXTERNAL PTFE BUSH

Manufactured from pure PTFE, these external bushes are shaped to minimise the chance of line catching the back of the bush.

TRADE QTY		
10		
CODE	DESCRIPTION	COLOUR
SEX1S	Slip Bush External	Orange
SEX2S	Slip Bush External	Yellow
SEX3S	Slip Bush External	Purple
SEX4S	Slip Bush External	Green
SEX5S	Slip Bush External	Red
SEX6S	Slip Bush External	Blue
SEX7S	Slip Bush External	Orange
SEX8S	External Bush	Yellow

BAZZERLA CARP

THE PRESTON BAZZERLA CARP RANGE CONTAINS FIVE MODELS THAT COVER MOST MODERN MATCH CARP FISHING. ROBUST GLASS STEMS, STRONG EYES AND THICK TIPS ARE ALL FEATURED IN THIS RANGE.



PB CARP 1

A short robust float with a fibreglass stem. Ideal for shallow or margin fishing with big baits.

TRADE QTY
10

CODE	SIZE
PBCARP1/10	4 x 10
PBCARP1/12	4 x 12
PBCARP1/14	4 x 14



PB CARP 2

Buoyant tipped dibber with a fibreglass stem which makes it ideal for fishing larger baits up in the water.

TRADE QTY
10

CODE	SIZE
PBCARP2/10	4 x 10
PBCARP2/12	4 x 12



PB CARP 3

Short float with a thick nylon tip and fibreglass stem. Bulbous body for holding still in windy conditions

TRADE QTY
10

CODE	SIZE
PBCARP3/10	4 x 10
PBCARP3/12	4 x 12
PBCARP3/14	4 x 14
PBCARP3/16	4 x 16



PB CARP 4

Ideal for fishing up to features on snake lakes with a fibreglass stem and thick nylon bristle.

TRADE QTY
10

CODE	SIZE
PBCARP4/10	4 x 10
PBCARP4/12	4 x 12
PBCARP4/14	4 x 14
PBCARP4/16	4 x 16



PB CARP 5

Suitable for fishing large baits in open water, the PB Carp 5 features a thick nylon tip and fibre glass stem.

TRADE QTY
10

CODE	SIZE
PBCARP5/14	4 x 14
PBCARP5/16	4 x 16
PBCARP5/18	4 x 18
PBCARP5/1	1.0g

PRESTON BAZZERLA

USED AND TRUSTED BY BRITAIN'S TOP MATCH ANGLERS. MADE FROM THE FINEST QUALITY MATERIALS AND INDIVIDUALLY CHECKED, PBS OFFER CONSISTENT PERFORMANCE.



PB PASTE

A robust self-cocking paste float. With an eye at the very tip, to prevent soft paste from being pulled off the hook.

TRADE QTY
10

CODE
PBPASTE/1
PBPASTE/2
PBPASTE/3



CHIANTI

Slim bodied float with a carbon stem and cane tip.

TRADE QTY
10

CODE	SIZE
CHIANTI/8	3x8
CHIANTI/10	4X10
CHIANTI/12	4X12
CHIANTI/14	4x14
CHIANTI/16	4X16

JIGGER FLOAT KITS



JIGGER FLOAT KITS

For the ultimate presentation when shallow fishing.

- Adjustable depth range
- Positive bite registration
- Simple and effective
- No resistance to the fish

2 PER PACK

TRADE QTY
5

CODE	DESCRIPTION
PJK/01	4-6mm Pellets
PJK/02	8-10mm Pellets



PB INTER SERIES

PB INTER 1

Slim design with painted nylon tips, ideal for small baits particularly pellet and corn. Good on the drop float when fishing through the water.

TRADE QTY	
10	
CODE	SIZE
PBINT1/0.2	0.2g
PBINT1/0.3	0.3g
PBINT1/0.4	0.4g

PB INTER 2

Slim round bodied design featuring a carbon stem and painted nylon bristle. Ideal for deeper water in calm conditions and slow moving rivers.

TRADE QTY	
10	
CODE	SIZE
PBINT2/0.3	0.3g
PBINT2/0.4	0.4g
PBINT2/0.6	0.6g
PBINT2/0.8	0.8g
PBINT2/1.0	1.0g

PB INTER 3

Slim round bodied design featuring a stable wire stem and painted nylon bristle. Ideal for deeper water in windy conditions and slow moving rivers.

TRADE QTY	
10	
CODE	SIZE
PBINT3/0.3	0.3g
PBINT3/0.4	0.4g
PBINT3/0.6	0.6g
PBINT3/0.8	0.8g
PBINT3/1.0	1.0g
PBINT3/2.0	2.0g
PBINT3/2.5	2.5g

PB INTER 9

Ultra slim long bodied float with wire stem and a plastic bristle, ideal for dotting down with pellets and other small baits.

TRADE QTY	
10	
CODE	SIZE
PBINT9/0.1	0.1g
PBINT9/0.2	0.2g
PBINT9/0.3	0.3g
PBINT9/0.4	0.4g
PBINT9/0.5	0.5g
PBINT9/0.6	0.6g
PBINT9/0.7	0.7g
PBINT9/0.8	0.8g
PBINT9/1.0	1.0g
PBINT9/1.25	1.25g
PBINT9/1.5	1.5g

PB INTER 5

Wire stemmed dibber for fishing shallow or in shallow water. The wire stem gives good stability in rough conditions and cocks the float quickly.

TRADE QTY	
10	
CODE	SIZE
PBINT5/10	4 x 10
PBINT5/12	4 x 12

PB INTER 10

Same shape as the Inter 9 but with a thicker plastic bristle, and a wire stem for stability.

TRADE QTY	
10	
CODE	SIZE
PBINT10/0.1	0.1g
PBINT10/0.2	0.2g
PBINT10/0.3	0.3g
PBINT10/0.4	0.4g
PBINT10/0.5	0.5g
PBINT10/0.6	0.6g
PBINT10/0.7	0.7g
PBINT10/0.8	0.8g
PBINT10/1.0	1.0g
PBINT10/1.25	1.25g
PBINT10/1.5	1.5g

PB INTER 11

Same slim body shape as the Inter 10, with a plastic bristle and 0.8mm fibre stem.

TRADE QTY	
10	
CODE	SIZE
PBINT11/0.1	0.1g
PBINT11/0.2	0.2g
PBINT11/0.3	0.3g
PBINT11/0.4	0.4g
PBINT11/0.5	0.5g
PBINT11/0.6	0.6g
PBINT11/0.7	0.7g
PBINT11/0.8	0.8g
PBINT11/1.0	1.0g
PBINT11/1.25	1.25g
PBINT11/1.5	1.5g

DESIGNED IN CONJUNCTION WITH ENGLAND INTERNATIONAL DES SHIPP, THE PB INTER SERIES IS A COLLECTION OF SOME OF HIS FAVOURITE PATTERNS. WITH A DISTINCTIVE PAINT FINISH AND HIGH QUALITY CARBON AND STEEL STEMS, ALL NYLON TIPS ARE PAINTED TO MAKE THEM GLOW BRIGHTLY WHEN LIGHT SHINES THROUGH THEM.

PB SILVERS

PB SILVER 1

The slim body down shape of this float combined with its carbon stem make it suitable for fishing with small baits on the drop in good conditions. Finished with a high quality carbon stem and a painted plastic tip which shows up better in bright light conditions.

TRADE QTY	
10	
CODE	SIZE
PBSIL1/0.3	0.3g
PBSIL1/0.4	0.4g
PBSIL1/0.6	0.6g
PBSIL1/0.8	0.8g
PBSIL1/1	1g
PBSIL1/1.5	1.5g

PB SILVER 2

This float features a slim body down shape and a wire stem, making it suitable for fishing small baits in the bottom quarter or when conditions are less favourable. Finished with a high quality wire stem and a painted plastic tip which shows up better in bright light conditions.

TRADE QTY	
10	
CODE	SIZE
PBSIL2/0.3	0.3g
PBSIL2/0.6	0.6g
PBSIL2/0.8	0.8g
PBSIL2/1	1g
PBSIL2/1.5	1.5g

PB SILVER 3

The round body of this float and its wire stem make it suitable for deeper water and fishing on the bottom. Finished with a high quality wire stem and a painted plastic tip which shows up better in bright light conditions.

TRADE QTY	
10	
CODE	SIZE
PBSIL3/0.5	0.5g
PBSIL3/1.25	1.25g
PBSIL3/2	2g
PBSIL3/2.5	2.5g

PB SILVER 4

Featuring a round body and carbon stem this is suitable for deeper water and fishing on the bottom in good conditions. Finished with a high quality wire stem and a painted plastic tip which shows up in bright light conditions.

TRADE QTY	
10	
CODE	SIZE
PBSIL4/0.5	0.5g
PBSIL4/0.75	0.75g
PBSIL4/1.25	1.25g
PBSIL4/2	2g
PBSIL4/2.5	2.5g

PB SILVER 5

PB silver 5 features a slim body and painted fibre bristle these are ideal for fishing delicate baits on or just touching the bottom. Finished with a high quality wire stem and painted fibre bristle.

TRADE QTY	
10	
CODE	SIZE
PBSIL5/0.1	0.1g
PBSIL5/0.2	0.2g
PBSIL5/0.6	0.6g
PBSIL5/0.8	0.8g
PBSIL5/1	1g

PB SILVER 6

This is a slim bodied float which is suitable for small fish on the drop or shallow its high quality carbon stem makes it suitable in good conditions.

TRADE QTY	
10	
CODE	SIZE
PBSIL6/8	4 x 8
PBSIL6/16	4 x 16

PB SILVER 7

The wire stem on this float makes it suitable for fishing shallow or on the drop when conditions require a more stable float.

TRADE QTY	
10	
CODE	SIZE
PBSIL7/10	4 x 10
PBSIL7/16	4 x 16

DEVELOPED IN COLLABORATION WITH DES SHIPP AND LEE KERRY THE SILVERS RANGE INCORPORATES SOME OF THE TRIED AND TRUSTED PATTERNS THEY FIND THEMSELVES USING ON THE INTERNATIONAL STAGE EACH YEAR, AS THE NAME SUGGESTS THIS RANGE IS ESPECIALLY SUITED TO SILVER FISH FISHING ON TRADITIONAL VENUES.

COLOURS SERIES

GREEN

Long nylon tip and carbon stem. For most baits and uses.

TRADE QTY	
10	
CODE	SIZE
PCGREEN/0.3	0.3g
PCGREEN/0.5	0.5g

ORANGE

Thick topped floats ideal for fishing in shallow water next to features with bigger baits.

TRADE QTY	
10	
CODE	SIZE
PCORANGE/10	4 x 10
PCORANGE/12	4 x 12
PCORANGE/14	4 x 14

BLUE

Cane tip and carbon stem. Versatile pattern for most baits and uses.

TRADE QTY	
10	
CODE	SIZE
PCBLUE/0.10	0.1g
PCBLUE/0.2	0.2g
PCBLUE/0.5	0.5g

YELLOW

Pear shaped body with a long thick nylon tip suitable for big baits in windy conditions.

TRADE QTY	
10	
CODE	SIZE
PCYELLOW/16	4 x 16

PINK

Line through dibbers with a wire stem particularly suitable for fishing shallow.

TRADE QTY	
10	
CODE	SIZE
PCPINK/8	4 x 8
PCPINK/10	4 x 10
PCPINK/12	4 x 12

RED

Thick nylon tip, carbon stem. For meat, corn, cat meat and worm.

TRADE QTY	
10	
CODE	SIZE
PCRED/0.1	0.1g
PCRED/0.2	0.2g
PCRED/0.3	0.3g
PCRED/0.4	0.4g
PCRED/0.6	0.6g

WHITE

Stable bulbous design with a thick plastic bristle suitable for fishing with worms, corn and pellets.

TRADE QTY	
10	
CODE	SIZE
PCWHITE/18	4 x 18
PCWHITE/1	1g
PCWHITE/1.5	1.5g

BLACK

Line through dibbers with a carbon stem suitable for fishing shallow.

TRADE QTY	
10	
CODE	SIZE
PCBLACK/8	4 x 8
PCBLACK/10	4 x 10
PCBLACK/12	4 x 12

GOLD

Slim body with a long thick nylon tip suitable for big baits in good conditions.

TRADE QTY	
10	
CODE	SIZE
PCGOLD/16	4 x 16

COLOURS RIGS

THE COLOURS RANGE OF FLOATS IS SPECIFICALLY DESIGNED FOR TOP MATCH ANGLERS. ALL MODELS HAVE EITHER A THIN, STRONG, CARBON STEM OR FINE WIRE FOR FINESSE SITUATIONS AND INCREASED STABILITY.

CARP COLOURS RIGS

The Preston Carp Colours range of rigs has been constructed using the same high quality components used by top match anglers throughout the country. The combination of the Colours range floats, Preston barbless PR hooks and ultra strong REFLO® Power™ make these rigs perfect for commercial fisheries where strength and reliability are essential. Full shooting instructions are printed on the reverse of the packaging and all are wound on to a Pop-up Slider Winder.



DISPLAY BOARD AVAILABLE FROM PAGE 137

TRADE QTY					
10					
CODE	SIZE	MAIN LINE	HOOKLENGTH	RIG LENGTH	HOOK SIZE
Colours BLUE					
PCBLRIG/02	0.2g	6lb	5lb	3m	16
PCBLRIG/03	0.3g	6lb	5lb	3m	16
PCBLRIG/05	0.5g	6lb	5lb	3.5m	16
TRADE QTY					
10					
CODE	SIZE	MAIN LINE	HOOKLENGTH	RIG LENGTH	HOOK SIZE
Colours GOLD					
PCGOLRIG/12	4 x 12	5lb	4lb	3m	14
PCGOLRIG/14	4 x 14	5lb	4lb	3m	14
TRADE QTY					
10					
CODE	SIZE	MAIN LINE	HOOKLENGTH	RIG LENGTH	HOOK SIZE
Colours GREEN					
PCGRRIG/05	0.5g	7lb	6lb	3.5m	16
PCGRRIG/075	0.75g	7lb	6lb	3.5m	14

TRADE QTY					
10					
CODE	SIZE	MAIN LINE	HOOKLENGTH	RIG LENGTH	HOOK SIZE
Colours YELLOW					
PCYELRIG/14	4 x 14	8lb	7lb	3m	12
PCYELRIG/16	4 x 16	8lb	7lb	3m	12
TRADE QTY					
10					
CODE	SIZE	MAIN LINE	HOOKLENGTH	RIG LENGTH	HOOK SIZE
Colours PURPLE					
PCPURIG/01	0.1g	7lb	6lb	3m	16
PCPURIG/02	0.2g	7lb	6lb	3m	16
TRADE QTY					
10					
CODE	SIZE	MAIN LINE	HOOKLENGTH	RIG LENGTH	HOOK SIZE
Colours RED					
PCRERIG/03	0.3g	8lb	7lb	3m	14
PCRERIG/04	0.4g	8lb	7lb	3.5m	14



TRADE QTY					
10					
CODE	SIZE	MAIN LINE	HOOKLENGTH	RIG LENGTH	HOOK SIZE
Colours SILVER (HEAVY)					
PCSIHRIG/01	0.1g	6lb	5lb	3m	18
PCSIHRIG/02	0.2g	6lb	5lb	3m	18
PCSIHRIG/03	0.3g	6lb	5lb	3m	18
Colours SILVER (LIGHT)					
PCSILRIG/01	0.1g	5lb	3.5lb	3m	20
PCSILRIG/02	0.2g	5lb	3.5lb	3m	18
PCSILRIG/03	0.3g	5lb	3.5lb	3m	18



LINE



REFLO® PRECISION POWER

The ideal rig and hooklength material supplied on 50m spools, its supple, strong and knots extremely well. We have been testing this superb line for 12 months. This development period has resulted in what we believe is genuinely one of the best lines available.

50M PER SPOOL

TRADE QTY
5

CODE	DIAMETER	BREAKING STRAIN	
		KG	LB
PCP/07	0.07mm	1.13lb	0.500kg
PCP/09	0.09mm	1.74lb	0.790kg
PCP/10	0.10mm	2.42lb	1.100kg
PCP/12	0.12mm	2.93lb	1.326kg
PCP/14	0.14mm	3.53lb	1.600kg
PCP/15	0.15mm	4.85lb	2.200kg
PCP/17	0.17mm	5.95lb	2.700kg
PCP/20	0.20mm	6.84lb	3.100kg
PCP/21	0.21mm	8.38lb	3.800kg
PCP/24	0.24mm	10.93lb	4.955kg

REFLO® POWER™

The UK's fastest selling line, is exceptionally strong, supple and clear. Designed with built-in stretch, it also makes it an excellent line for pole rigs. Available in 14 sizes, REFLO® Power™ has quickly become the first choice hooklength and rig line for top match anglers.

100M PER SPOOL

TRADE QTY
5

CODE	DIAMETER	BREAKING STRAIN		CODE	DIAMETER	BREAKING STRAIN	
		KG	LB			KG	LB
PL/05	0.05mm	0.297kg	10oz	PL/13	0.13mm	2.136kg	4lb 12oz
PL/06	0.06mm	0.374kg	12oz	PL/15	0.15mm	2.683kg	5lb 14oz
PL/07	0.07mm	0.434kg	1.0lb	PL/17	0.17mm	3.088kg	6lb 12oz
PL/08	0.08mm	0.812kg	1lb 12oz	PL/19	0.19mm	3.355kg	7lb 6oz
PL/09	0.09mm	0.967kg	2lb 2oz	PL/21	0.21mm	4.062kg	8lb 15oz
PL/10	0.10mm	1.205kg	2lb 10oz	PL/24	0.24mm	5kg	11lb
PL/11	0.11mm	1.521kg	3lb 6oz	PL/26	0.26mm	5.7kg	12lb 5oz



REFLO® POWER MAX®

High specification offers all the properties required from a modern fishing line. The line's soft, supple nature allows for long distance casting, this makes it an ideal line for feeder and waggler fishing. High abrasion resistance and superb knot strength making it the obvious choice.

150M PER SPOOL

TRADE QTY
5

CODE	DIAMETER	BREAKING STRAIN	
		LB	KG
PMRL/3	0.16mm	3lb	1.36kg
PMRL/4	0.18mm	4lb	1.81kg
PMRL/5	0.20mm	5lb	2.27kg
PMRL/6	0.23mm	6lb	2.72kg
PMRL/8	0.26mm	8lb	3.63kg
PMRL/10	0.28mm	10lb	4.54kg



REFLO® POWER MAX® CLEAR

Following on from the huge success of the original Power Max® we recognised that its dark colour wasn't suitable for all applications and developed its clear equivalent. Just as strong and tough but more suitable for clear water angling and float fishing.

150M PER SPOOL

TRADE QTY
5

CODE	DIAMETER	BREAKING STRAIN	
		LB	KG
PMCLR/3	0.16mm	3lb	1.36kg
PMCLR/4	0.18mm	4lb	1.81kg
PMCLR/5	0.20mm	5lb	2.27kg
PMCLR/6	0.23mm	6lb	2.72kg
PMCLR/8	0.26mm	8lb	3.63kg
PMCLR/10	0.28mm	10lb	4.54kg



REFLO® BRAIDCAST SUPERIOR SINKING BRAID

Designed for feeder fishing, its awesome casting performance makes long range fishing easier and combined with the Braidcast Tapered Mono Leader hook, pulls at close range are almost totally eliminated.

- Quick Sinking Reel Line Braid
- Ultra low diameter
- Minimum stretch
- Low visibility

TRADE QTY
5

CODE	DESCRIPTION
BC/08	0.08mm
BC/10	0.10mm
BC/12	0.12mm



REFLO® BRAIDCAST TAPERED MONO LEADER

Designed to be used with braid, the mono absorbs shock, preventing crack offs and reducing hook pulls. 15 metre lengths allow leaders to be customised, 5 leaders per spool.

- 0.18mm – 0.32mm (5 – 12lb)

TRADE QTY
5

CODE	DESCRIPTION
BC/TL	Reflo® Braidcast Tapered Leader

PR EYED HOOKS

THE PRESTON RANGE OF HOOKS FOR HAIR-RIGGING HAS NEVER LET ME DOWN.
TOMMY PICKERING

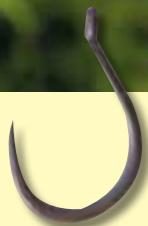

PR C1

In-turned point helps increase hooking capabilities, while the out-turned eye ensures they hang straight on your line and reduces undue stress on your hooklength.

TRADE QTY
10

CODE	DESCRIPTION
PRC1-12	Size 12
PRC1-14	Size 14
PRC1-16	Size 16
PRC1-18	Size 18



PR 36

Barbless eyed hook with out-turned eye. Ideal for hair-rigging for match carp.

TRADE QTY
10

CODE	DESCRIPTION
PR36-10	Size 10
PR36-12	Size 12
PR36-14	Size 14
PR36-16	Size 16
PR36-18	Size 18
PR36-20	Size 20

PR 27

Eyed, barbless, round bend. Bronze finish.

TRADE QTY
10

CODE	DESCRIPTION
PR27-10	Size 10
PR27-12	Size 12
PR27-14	Size 14
PR27-16	Size 16
PR27-18	Size 18



PR 39

Same thick wire as the PR 38 but with a barb for situations where barbed hooks are allowed.

TRADE QTY
10

CODE	DESCRIPTION
PR39-10	Size 10
PR39-12	Size 12
PR39-14	Size 14
PR39-16	Size 16
PR39-18	Size 18

CARP BARBLESS HOOKS TO NYLON

A RANGE OF PRE-TIED HOOKS TO NYLON PERFECT FOR COMMERCIAL FISHERY APPLICATIONS

Available in three patterns tied to high quality mono.

CARP BARBLESS

Suitable for fisheries where smaller carp and F1's are the norm or for winter fishing. Ideally shaped for pellets and corn and tied to well balanced breaking strains of line.

TRADE QTY	
10	
CODE	DESCRIPTION
PHNC/12	Size 12
PHNC/14	Size 14
PHNC/16	Size 16
PHNC/18	Size 18
PHNC/20	Size 20



CARP BARBLESS STRONG

A superb all-round shape ideal for a variety of baits and situations. The perfect step up for bigger fish and more snaggy pegs, the lines have been carefully chosen to match the hooks.

TRADE QTY
10

CODE	DESCRIPTION
PHNCS/12	Size 12
PHNCS/14	Size 14
PHNCS/16	Size 16
PHNCS/18	Size 18

CARP BARBLESS XTRA STRONG

The strongest hooks in the range are combined with equally robust line. These extra strong patterns are ideal for big fish or margin fishing situations.

TRADE QTY
10

CODE	DESCRIPTION
PHNCXS/12	Size 12
PHNCXS/14	Size 14
PHNCXS/16	Size 16
PHNCXS/18	Size 18



HOOKS & LINE : PR 36 BARBLESS HAIR RIGS

PR 36 BARBLESS HAIR RIGS

Constructed using the PR 36 Hook which, due to its out-turned eye, gives vastly improved presentation and hooking characteristics. Our pre-tied rigs offer the opportunity of hair-rigging to anglers of all abilities. Supplied in two sizes, 15" (38cm) to suit normal feeder fishing situations and the shorter 4" (10cm) version for method feeder fishing.

8 PER PACK

TRADE QTY

10

4" (10CM) HAIR RIGS

CODE	SIZE	STRENGTH	DIAMETER
PHRS/10	10	10lb	0.25mm
PHRS/12	12	8lb	0.23mm
PHRS/14	14	8lb	0.23mm
PHRS/16	16	7lb	0.20mm
PHRS/18	18	6lb	0.18mm

15" (38CM) HAIR RIGS

CODE	SIZE	STRENGTH	DIAMETER
PHRL/10	10	10lb	0.25mm
PHRL/12	12	8lb	0.23mm
PHRL/14	14	8lb	0.23mm
PHRL/16	16	7lb	0.20mm
PHRL/18	18	6lb	0.18mm



HAIR RIGS WITH BAIT BANDS

Hair Rigs with Bait Bands are constructed using our famous PR 36 barbless hook and ultra strong clear mono. The latex bait bands will stretch to accommodate most pellet sizes and can also be pulled into pre-drilled pellets. Available in two length options, 4" (10cm) for the Method feeder and 15" (38cm) for normal feeders and pole rigs.

8 PER PACK

15" (38CM) HAIR RIGS

TRADE QTY			
10			
CODE	SIZE	STRENGTH	DIA.
PHRBL/10	10	10lb	0.25mm
PHRBL/12	12	8lb	0.23mm
PHRBL/14	14	8lb	0.23mm
PHRBL/16	16	7lb	0.20mm
PHRBL/18	18	6lb	0.18mm

4" (10CM) HAIR RIGS

TRADE QTY			
10			
CODE	SIZE	STRENGTH	DIA.
PHRBS/10	10	10lb	0.25mm
PHRBS/12	12	8lb	0.23mm
PHRBS/14	14	8lb	0.23mm
PHRBS/16	16	7lb	0.20mm
PHRBS/18	18	6lb	0.18mm

PR 36 WITH OUT-TURNED EYE

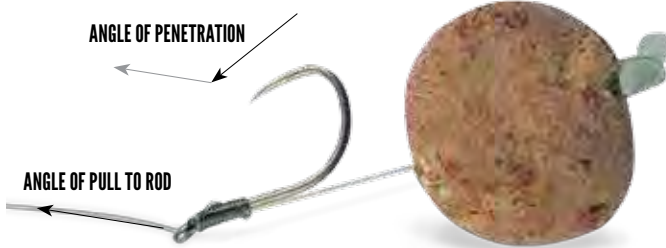

CARP HOOK WITH STRAIGHT EYE



HAIR RIGGING

BARBLESS HAIR RIGS ARE PERFECT FOR PRESENTING A WIDE VARIETY OF BAITS. HERE'S HOW TO MOUNT A SOFT PELLETT.



Expertly tied straight from the packet, the hair is the correct length for a wide variety of baits.

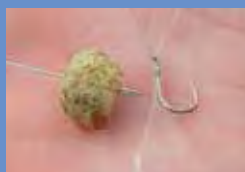

Push a baiting needle through the pellet ready to mount on the hair. You can use the same method for boilies and sweetcorn.

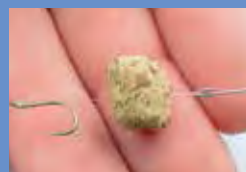

Hook the baiting needle onto the loop of the hair and pull through moving the bait onto the hair.



Remove the baiting needle and insert a bait stop into hair loop. Use a bait stop that's either clear or the same colour as the bait.

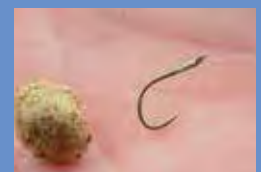

Gently ease the pellet down the hair until it sits on the bait stop. This will prevent the stop falling out on the cast.



STICKY FEEDERS

Developed for use in deeper water where you may need to add Sonubaits Sticky Pellet to your pellets to make sure they reach the bottom still inside the feeder. They can also be used in conjunction with sticky maggot. The increased number of holes allows water to penetrate around the chosen feed ensuring it releases when the feeder has reached its desired location.



INLINE STICKY FEEDERS

When used in conjunction with a Method Feeder Quick Change Bead, the Inline version is the most direct and positive way of fishing with Sticky Pellet or maggot. Can be used on commercials but also becoming popular for chub and barbel on rivers. Available in three frame sizes.

TRADE QTY	
10	
CODE	DESCRIPTION
PFSI/S20	Inline Sticky Feeder - Small - 20g
PFSI/S30	Inline Sticky Feeder - Small - 30g
PFSI/L25	Inline Sticky Feeder - Large - 25g
PFSI/L40	Inline Sticky Feeder - Large - 40g
PFSI/XL40	Inline Sticky Feeder - XL - 40g
PFSI/XL50	Inline Sticky Feeder - XL - 50g

ELASTICATED STICKY FEEDERS

Where allowed, the elasticated version gives added shock absorption to your rig to minimise hook pulls and breakages when used in conjunction with short hooklengths. Can be employed with maggots or pellets on rivers and still waters alike. Available in three frame sizes.

TRADE QTY	
10	
CODE	DESCRIPTION
PFSE/S20	Elasticated Sticky Feeder - Small - 20g
PFSE/S30	Elasticated Sticky Feeder - Small - 30g
PFSE/L25	Elasticated Sticky Feeder - Large - 25g
PFSE/L40	Elasticated Sticky Feeder - Large - 40g
PFSE/XL40	Elasticated Sticky Feeder - XL - 40g
PFSE/XL50	Elasticated Sticky Feeder - XL - 50g



“CHOOSING THE CORRECT FEEDER IS VITAL AND WILL HELP YOU GET THE MOST FROM EVERY PEG YOU DRAW.”
EMMA PICKERING

PELLET FEEDERS



INLINE PELLET FEEDERS

Preston Inline Pellet Feeders have been developed to be used with damp pellets. Using a short hooklink you can present your hookbait right amongst your feed.

Our pellet feeders feature a flat design which makes them ideal for fishing tight to islands where the dimpled lead will help them grip on the sloping margins. Their line through nature means they can be fished running or semi fixed for safety.

TRADE QTY
10

CODE	DESCRIPTION
PFI/M15	Inline Pellet Feeder - Micro - 15g
PFI/M25	Inline Pellet Feeder - Micro - 25g
PFI/S20	Inline Pellet Feeder - Small - 20g
PFI/S30	Inline Pellet Feeder - Small - 30g
PFI/L25	Inline Pellet Feeder - Large - 25g
PFI/L40	Inline Pellet Feeder - Large - 40g
PFI/XL40	Inline Pellet Feeder - XL - 40g
PFI/XL50	Inline Pellet Feeder - XL - 50g

ELASTICATED PELLET FEEDERS

Designed for use with dampened pellets, the elasticated version allows you to use a short hooklength to present your hook bait right amongst your feed. The short elasticated section absorbs the shock of sudden takes and can easily be removed to be re-elasticated.

The flat botttomed design makes them unobtrusive when cast tight to island margins, whilst the dimpled lead means they are better equipped to hold on slopes.

TRADE QTY
10

CODE	DESCRIPTION
PFE/M15	Elasticated Pellet Feeder - Micro - 15g
PFE/M25	Elasticated Pellet Feeder - Micro - 25g
PFE/S20	Elasticated Pellet Feeder - Small - 20g
PFE/S30	Elasticated Pellet Feeder - Small - 30g
PFE/L25	Elasticated Pellet Feeder - Large - 25g
PFE/L40	Elasticated Pellet Feeder - Large - 40g
PFE/XL40	Elasticated Pellet Feeder - XL - 40g
PFE/XL50	Elasticated Pellet Feeder - XL - 50g



BANJO FEEDERS

Masterminded by commercial expert Andy Findlay, this style of feeder literally provides 'dinner on a plate' for commercial carp. Loaded with the hookbait in the middle forcing the feed pellets to erupt out, provides the perfect presentation every time as the area of feed is so confined. The loaded shape creates a weight forward set up, meaning casting distance and accuracy is improved. The feeders can be used on their own, or for the perfect loading every time used in conjunction with the Quick Release Moulds designed specifically for the Banjo feeders.



INLINE BANJO FEEDER

Accepts a multitude of our feeder link accessories, such as ring and standard swivels, as well as the Quick Change Method Feeder Bead, each of which will provide a safe semi-fixed rig. For a completely free running rig, they can be used in conjunction with a Korum Quick Change Bead.

TRADE QTY
10

CODE	DESCRIPTION
BFI/S15	Small Inline 15g
BFI/S30	Small Inline 30g
BFI/S45	Small Inline 45g
BFI/L15	Large Inline 15g
BFI/L30	Large Inline 30g
BFI/L45	Large Inline 45g

ELASTICATED BANJO FEEDER

The same shape and design as the In-line variant, the elasticated version features a length of shock absorbing elastic running through the central tube. The tube helps to prevent the elastic from perishing, and provides a very neat set up. Available in two frame sizes.

TRADE QTY
10

CODE	DESCRIPTION
BFE/S15	Small Elasticated 15g
BFE/S30	Small Elasticated 30g
BFE/S45	Small Elasticated 45g
BFE/L15	Large Elasticated 15g
BFE/L30	Large Elasticated 30g
BFE/L45	Large Elasticated 45g

BANJO FEEDER QUICK RELEASE MOULD

Developed to allow perfect loading of groundbait or pellets onto the Banjo Feeder, ensuring optimum presentation and more accurate casting. Featuring the same quick release button mechanism as found on the standard flat method feeder moulds.

TRADE QTY
5

CODE	DESCRIPTION
BQRM/S	Small Banjo Mould
BQRM/L	Large Banjo Mould



THREE WAYS TO: LOAD A BANJO FEEDER

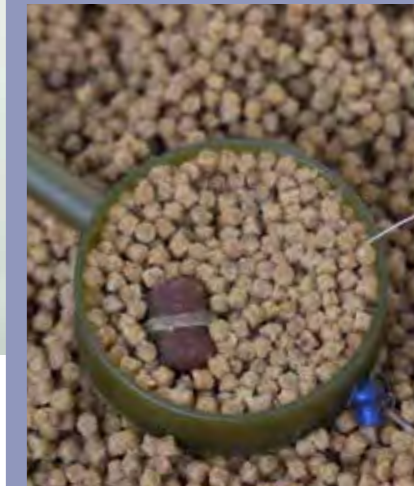

1. A TINY AMOUNT OF BAIT IS PERFECT IN THE COOLER MONTHS. PRESSED IN BY YOUR THUMB.



2. THE RIGHT AMOUNT FOR ALL BUT THE MOST DIFFICULT DAYS. USE YOUR PALM TO ACHIEVE THIS.



3. WHEN THE FISH REALLY WANT SOME BAIT, USE THE MOULD TO FEED PLENTY.



STOP NEEDLE

For pushing both Rapid In-Stops and Rapid Stops through a variety of baits.

TRADE QTY
10

CODE	DESCRIPTION
PRAP/03	Stop Needle

PULLER NEEDLE

Ideal to pull a conventional hair loop through soft baits, or stretching a band into a pre drilled hard bait.

TRADE QTY
10

CODE	DESCRIPTION
PRAP/04	Puller Needle

SUPER FINE GATED NEEDLE

A blunt gated needle ideal for hair rigging soft baits.

TRADE QTY
5

CODE	DESCRIPTION
PRAP/06	Super Fine Gated Needle

SUPER FINE BAITING NEEDLE

Pointed super fine needle for hair rigging more delicate baits, keeping splitting to a minimum.

TRADE QTY
5

CODE	DESCRIPTION
PRAP/07	Super Fine Baiting Needle



RAPID BAIT DRILL

Rotating body fits comfortably to your hand making drilling baits easier, perfect for pre drilling hard baits before mounting them on a hair.

TRADE QTY
5

CODE	DESCRIPTION
PRAP/05	Rapid Bait Drill



RAPID HAIR STOP LOOP TYERS

For the tying of consistent sized hair loops with captive stops, the Rapid Hair Stop Loop Tyer allows loops to be easily tied with a Rapid Stop or Rapid In-Stop trapped inside. 2 sizes per pack.

TRADE QTY
5

CODE	DESCRIPTION
PRAP/08	Rapid Hair Stop Loop Tyers

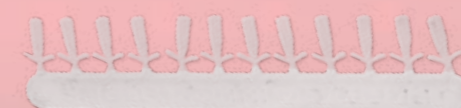

RAPID STOPS

Quick and easy to use captive hairstop suitable for a wide variety of baits in many different fishing situations.

TRADE QTY
10

CODE	DESCRIPTION
PRAP/01	Rapid Stops

RAPID IN-STOPS

Ideal for a wide variety of baits, the Rapid In-Stop is quick to use and unobtrusive.

TRADE QTY
10

CODE	DESCRIPTION
PRAP/02	Rapid In-Stops

USING RAPID LOOP TYERS



THREAD YOUR RAPID STOP OR IN-STOP ON TO YOUR LINE



FORM A LOOP TRAPPING THE STOP IN THE MIDDLE



WRAP THE MIDDLE OF THE LOOP AROUND THE LOOP TYER



TWIST THE LOOP TYER ONCE OR TWICE AS PREFERRED



PUSH THE STOP INTO THE HOLE IN THE END OF THE LOOP TYER POINTED END FIRST



TIGHTEN DOWN THE LOOP ON TO THE NECK OF THE LOOP TYER

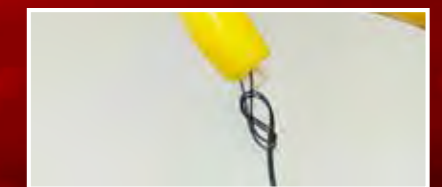

PULL THE NOW KNOTTED LOOP OFF THE NECK OF THE LOOP TYER, MOISTEN AND PULL TIGHT



TRIM THE TAG ENDS ON THE NOW FINISHED LOOP WITH YOUR STOP TRAPPED INSIDE



ANTI-TWIST PTFE BUSH

PELLETPULT

- PTFE BUSH ANTI-TWIST TECHNOLOGY
- FLAT-BASE PELLET POUCH
- AMBER-CORE DURABLE HOLLOW ELASTIC
- RIGID NON-FLEX FRAME
- ERGONOMIC SOFT-GRIP HANDLE



FLAT BASE PELLET POUCH



AMBER-CORE DURABLE HOLLOW ELASTIC



RIGID NON-FLEX FRAME



ERGONOMIC SOFT-GRIP HANDLE

PELLETPULT

CONTAINING PTFE ANTI-TWIST TECHNOLOGY



GROUNDBAIT CATAPULT

Fitted with a large preformed groundbait pouch, swivelling elastic attachments and heavy elastic. Will fire groundbait up to 50m.

TRADE QTY	
5	
CODE	DESCRIPTION
GBCAT/01	Groundbait Catapult
CATP/GB	Groundbait Catapult Pouch Only
KCAT/03	Groundbait Catapult Elastic Only

2 SIZE OPTIONS



new

new

PELLETPULT SPARE POUCH

Replacement flat bottomed pellet pouch, pre-fitted with colour coded cord.

TRADE QTY	
5	
CODE	DESCRIPTION
PCAT/03	Small - 4-8mm
PCAT/04	Large - 6-10mm

PELLETPULT SPARE ELASTIC

Replacement amber core durable hollow elastic, pre fitted with location peg.

TRADE QTY	
5	
CODE	DESCRIPTION
PCAT/05	Small - 4-8mm
PCAT/06	Large - 6-10mm



2 SIZE OPTIONS

new



PELLETPULT

Pelletpults have been designed with commercial fisheries in mind, specifically for feeding pellets. The flat bottomed pouch ensures the pellets are tightly grouped when feeding and the dual PTFE bushes built into the frame maintain twist free performance. Two different sizes cover all feeding requirements from 4mm to 10mm pellets. Can also be used for conventional baits such as maggots and casters.

TRADE QTY	
5	
CODE	DESCRIPTION
PCAT/01	Small - 4-8mm
PCAT/02	Large - 6-10mm



new

new

SPOT ON KUP KIT

A lighter and stiffer version of the original model. It has the Spot On facility to instantly adjust the length of the top kit making it perfect if your power and match top kits are different lengths. With reinforced ends, to allow cutting back to suit all poles.

TRADE QTY		
3		
CODE	DESCRIPTION	DIA.
KUPSG	GiS Spot On Kup Kit	18mm
KUPSPT	ProType Spot On Kup Kit	24mm

KUP KITS

Manufactured from high quality carbon to make them as stiff as possible when cupping in bait, especially at long range. Designed with a long reinforcement to the base of the largest section so it can be cut back as required.

TRADE QTY		
3		
CODE	DESCRIPTION	OTHER
KUPG	GiS Kup Kit	18mm
KUPPT	ProType Kup Kit	24mm

PRESTON KUP SET

Supplied in packs of two different cup sizes with brass threads. They come with two adaptors, each with a different internal diameter, 4mm and 5mm, for different diameter pole sections.

TRADE QTY	
10	
CODE	DESCRIPTION
KUP3	Preston Kup Set

DOUBLE KUP

For anglers that want to feed a lot of bait or a combination of baits without shipping out multiple times. Fill it up for margin fishing and targeting big fish when a lot of bait is required. Double up for the continental style approach of feeding two different groundbaits or learn mixes in one go. Mix it up for feeding a combination of baits, such as pellets and groundbait.

350ML CAPACITY

TRADE QTY	
5	
CODE	DESCRIPTION
KUP13	Double Kup



new



SLIP JOINT ALIGNERS

Not only improve shipping together speed, they prevent the ends of pole sections getting damaged.

TRADE QTY			
10			
CODE	SIZE	CODE	SIZE
JA00S	00	JA6S	6
JA0S	0	JA7S	7
JA1S	1	JA8S	8
JA2S	2	JA9S	9
JA3S	3		

POLE END PROTECTORS

Designed to protect pole end sections during transit. Available in a range of sizes to fit all larger pole sections, can be left in place during fishing.

TRADE QTY	
9	
CODE	DESCRIPTION
PEP38	38mm
PEP40	40mm
PEP42.5	42.5mm
PEP45	45mm
PEP48	48mm



JOINT SAVE

Simply paint onto joints to prevent excessive wear.

JOINT RESTORER

An great way to build-up worn pole joints. This liquid carbon hardens with a top coat of Joint Save.

TRADE QTY	
5	
CODE	DESCRIPTION
JREST	Joint Restorer
JSAVEB	Joint Save



TOP TUBES

For safely storing elasticated top two sections. Convenient and make best use of space. The specially designed elastic protector and end cap ensure that elastics aren't damaged.

TRADE QTY	
10	
CODE	DESCRIPTION
TUBE7	Top Tubes



UNI CAD POTS

A top quality range of pots that will securely fit onto any tip from a fine 2.5mm up to an ultra thick 8.0mm thanks to the clever elastic attachment and soft over-moulded rubber base. Available in four sizes, each supplied in a twin pack complete with four different lids, enabling the angler to match the lid to the conditions and baits being used.

TRADE QTY	
10	
CODE	DESCRIPTION
POT14	Micro
POT15	Small
POT16	Medium
POT17	Large



PASTE POTS

Developed with Andy Findlay, these are large enough to deliver loose feed pellets and soft paste hookbait in the required area. There are three size fittings to cope with the range of depths you are likely to encounter.

TRADE QTY	
5	
CODE	DESCRIPTION
POT12	Paste Pot 12mm
POT13	Paste Pot Mixed Sizes 7mm, 10mm, 12mm

DROP 'N' DRIP UNI CAD POTS

Drop 'N' Drip pots are ideal for feeding twice. The domed lid will take a ball of dampened pellets or groundbait whilst the space underneath will accommodate loose pellets which can be shaken out after your initial feed has been deposited.

TRADE QTY	
10	
CODE	DESCRIPTION
POT18	Micro/Small
POT19	Medium/Large



new

SOFT CAD POTS

Made from soft rubberised material to grip most popular sized top kits (5mm-7mm) without causing damage. The perforated design serves several purposes, the main advantage is to counteract the vacuum effect which can prevent bait from releasing in a conventional pot, it also reduces the weight on the end of your pole and reduces wind resistance.

Supplied with four lids in two different colours, the orange version is easily visible to make sure the pot is fully turned before you empty it.

TRADE QTY	
10	
CODE	DESCRIPTION
POT20	Small
POT21	Medium
POT22	Large



OLIVETTES

Streamlined easily changeable olivettes complete with soft silicone tube for easy attachment.

TRADE QTY
5

CODE	DESCRIPTION
OL/0.2	0.20g Olivettes
OL/0.3	0.30g Olivettes
OL/0.4	0.40g Olivettes
OL/0.5	0.50g Olivettes
OL/0.6	0.60g Olivettes
OL/0.8	0.80g Olivettes
OL/1	1.00g Olivettes
OL/1.2	1.20g Olivettes
OL/1.5	1.50g Olivettes
OL/2	2.00g Olivettes
OL/2.5	2.50g Olivettes
OL/4	4.00g Olivettes



WINDER ANCHORS

Produced from high quality rubber that not only stretches well but also lasts a long time.

TRADE QTY
20

CODE	DESCRIPTION
PWA	Winder Anchors

PLUMMET

Large diameter top hole and grooved body for line location. Non-toxic alloy with flat base for accurate plumbing.

2 PER PACK
TRADE QTY
10

CODE	DESCRIPTION
PLUM/S	Small 14g
PLUM/L	Large 18g



MICRO SILICONE

Ultra fine, high performance silicone tube. Will fit the finest wire and carbon pole stems.

TRADE QTY
20

CODE	DESCRIPTION
SILM	Mixed
SILIC/GREY	0.25mm
SILIC/RED	0.40mm
SILIC/GREEN	0.50mm

POLE FLOAT SILICONE

High performance fine diameter silicone tube for thicker bristles and stems. Available in thick and stick float.

TRADE QTY
20

CODE	DESCRIPTION
SILT	Thicker Bristle Silicone
SILB	Stick Float Silicone

PELLET WAGGLER FLOAT STOP KIT

Perfect for securely locking pellet wagglers to your mainline without the need for shot, which can often damage the line resulting in lost fish.

5 PER PACK
TRADE QTY
10

CODE	DESCRIPTION
PWFSK	Pellet Wagglers Float Stop Kit

FLOAT STOPS

Can be used for stopping sliding floats and also for creating semi-fixed feeder and bomb rigs.

TRADE QTY
10

CODE	DESCRIPTION
PFS/STD	Standard
PFS/MINI	Mini
PFS/MIC	Micro

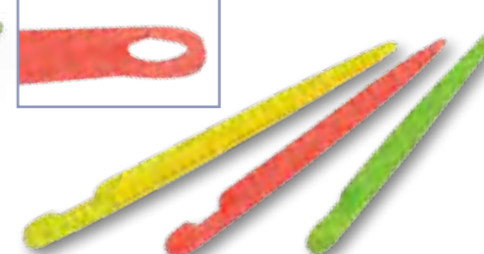
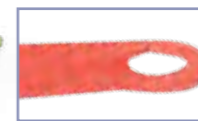

LOOP TYER

Loop tyer and disgorger comes in packs of two, supplied with full instructions.

TRADE QTY
5

CODE	DESCRIPTION
PLT/S	Small
PLT/L	Large

DISGORGER

Plastic disgorger with two different ends. One end has traditional slot and the other a loop end for larger hooks.

TRADE QTY
100

CODE	DESCRIPTION
DIS/SM	Small
DIS/L	Large

BRISTLE GREASE

Fluorescent coloured pole tip grease that can be applied to fine pole tips to help them sit correctly. Very useful for wire tips. 1 orange and 1 yellow per pack.

TRADE QTY
10

CODE	DESCRIPTION
BGRS	Bristle Grease



QUICK CONE & BAIT MOULD

Can be used in various ways, making it a must have for any match angler. The simple plunger mechanism works perfectly with either pellets or groundbait. Available in three sizes, the smallest is suitable when only a small amount of bait is required, where as the larger sizes are ideal for a more positive approach and are also perfect for creating balls of groundbait.

TRADE QTY
5

CODE	DESCRIPTION
QCM/S	Small
QCM/M	Medium
QCM/L	Large



QUICK BANDER

Makes baiting up using bait bands quick and easy. Can be used to attach bait directly to the hook or hair.

TRADE QTY
5

CODE	DESCRIPTION
QBAND	Quick Bander



BIG FLOAT WAGGLER ADAPTORS

Designed for use with loaded splasher wagglers where locking shot aren't required. This version has a metal stem and copes well with repeated casting.

TRADE QTY
10

CODE	DESCRIPTION
BWAGAD	Big Float Wagglers Adaptors



WAGGLER ADAPTORS

The soft plastic Wagglers Adaptor is designed for attaching loaded floats without the need for shot.

TRADE QTY
10

CODE	DESCRIPTION
WAGAD	Wagglers Adaptors

BAIT BANDS

High quality latex bait bands in three sizes to cover almost all bait sizes.

100 PER PACK
TRADE QTY
10

CODE	DESCRIPTION
PBB/32	3.2mm
PBB/48	4.8mm
PBB/MIC	Micro



new

ABSOLUTE CARP HANDLES

Super strong, power handles purpose designed for bagging on commercials, featuring rubberised grip for easy handling and pinned thread for maximum strength. The 4m version also doubles as great big fish river handle.

TRADE QTY

1

CODE DESCRIPTION

ABCH/2.7M 2.7m

ABCH/4M 4m

new

ABSOLUTE MATCH HANDLES

Strong, slim and lightweight dedicated match handles with rubberised grip. Each handle can be used in 1m increments making them ultra-versatile and the pinned threads offer increased strength. The 5m version is the ultimate competition handle.

TRADE QTY

1

CODE DESCRIPTION

ABMH/3M 3m

ABMH/4M 4m

ABMH/5M 5m

NETS & BROLLIES : ABSOLUTE CARP & MATCH HANDLES



ABSOLUTE ABSOLUTE CARP & MATCH HANDLES



HAIR NET II

Manufactured with a strong square profile frame with the mesh attached to the inside of the frame. The fine nylon mesh makes it suited to hair rigging because your hair or Quick Stop won't pass through the mesh. This net is also perfect for traditional silver fish fishing.

TRADE QTY

3

CODE DESCRIPTION

PHNET2/18 18" Hair Net II

PHNET2/20 20" Hair Net II

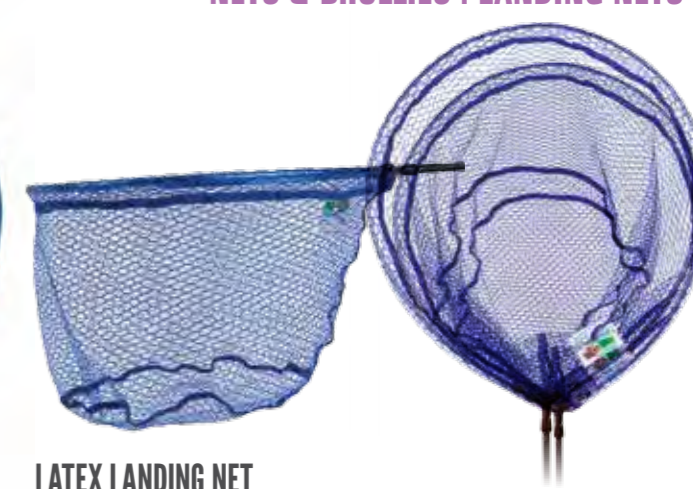

LATEX LANDING NET

Suitable for match carp, they feature a strong 'D' profile frame and latex coated mesh which is tougher and more robust than standard mesh. The open mesh design makes them very manoeuvrable in water and their shallow depth makes unhooking fish quick and easy.

TRADE QTY

3

CODE DESCRIPTION

PSLNET/18 18" Landing Net

PSLNET/20 20" Landing Net



DEEP QUICK DRY LANDING NET

Manufactured from a square profile for increased strength, the frame has the mesh fixed inside making this net easily manoeuvrable through the water. Features a deeper mesh making it suitable for larger carp.

TRADE QTY

3

CODE DESCRIPTION

PQDNET2/18 18" Quick Dry Landing Net

PQDNET2/20 20" Quick Dry Landing Net



QUICK DRY LANDING NET

Manufactured from a strong square profile frame, the Quick Dry Landing net is attached on the inside of the frame making it neater and easier to pass through the water. The large mesh aids manoeuvrability and the depth of the net is ideal for match sized carp.

TRADE QTY

3

CODE DESCRIPTION

PQDNET/18 18" Quick Dry Landing Net

PQDNET/20 20" Quick Dry Landing Net

SUPALITE NETS

Featuring a strong, lightweight spoon shaped frame with free flowing nylon mesh. Suitable for all species and perfect when used in conjunction with long landing net handles.

TRADE QTY

3

CODE DESCRIPTION

PNET1/45 45cm Supalite Landing Net

PNET1/50 50cm Supalite Landing Net



NETS & BROLLIES : LANDING NETS

NETS & BROLLIES : KEEPNETS

NETS & BROLLIES : KEEPNETS

3 SIZE OPTIONS

new



3 SIZE OPTIONS

QUICK DRY KEEPNET

Manufactured from a mesh that holds much less water than other mesh nets which enables them to dry out much quicker after use. Very useful on flowing water as the mesh offers less resistance. All hoops have tough corner guards for protection.

TRADE QTY
1

CODE	DESCRIPTION
FKNET4	3m Quick Dry Keepnet
FKNET5	3.5m Quick Dry Keepnet
FKNET6	4m Quick Dry Keepnet



3M BLUE KEEPNET

Manufactured from blue micro mesh, this 3m long rectangular keepnet features a positive Fixangle attachment and Preston branding around the top ring.

TRADE QTY
3

CODE	DESCRIPTION
FKNET8	3m Blue Keepnet



QUICK DRY SILVER KEEPNET

Compact 2.5m silver fish keepnet in Quick Dry Mesh with Fixangle top ring. An ideal canal net or second net for commercial fishing.

TOP RING: 45CM X 35CM

TRADE QTY
1

CODE	DESCRIPTION
FKNET9	2.5m Quick Dry Silver Keepnet



KEEPNET COMBO

Comprising a 3m micro mesh blue keepnet and a 2.5m micro mesh silver keepnet. The perfect combination to comply with most commercial fishery rules.

TOP RING: 50CM X 40CM

TRADE QTY
1

CODE	DESCRIPTION
FKNET10	Keepnet Combo



BLUE CARP KEEPNET

Available in 3m, the Blue Carp Keepnet is made from ultra soft material that conforms to commercial fishery requirements. Top ring 50cm x 40cm.

TRADE QTY
1

CODE	DESCRIPTION
FKNET2	3m Blue Carp Keepnet

new

COMBO



50" FLAT BACK BROLLY

Based on the legendary Flat Back Brolly. This 50" Flat Back design, for added stability, now comes with a 210D waterproof nylon cover with taped seams. Now lighter, but just as waterproof as its predecessor.

- Waterproof taped seams
- Pegging points
- Angle tilt
- Pegs supplied
- Storage sleeve

TRADE QTY	2
-----------	---

CODE	DESCRIPTION
LUG/19	50" Flat back Brolly



UV 50+
ULTRA VIOLET
PROTECTION



UV 50+
ULTRA VIOLET
PROTECTION

50" FLAT BACK BROLLY WITH ZIPS

A lightweight Flat Back Brolly fitted with two zips in the cover to enable convenient shipping of your pole.

- Waterproof taped seams
- Pegging points
- Angle tilt
- Pegs supplied
- Storage sleeve

TRADE QTY	2
-----------	---

CODE	DESCRIPTION
LUG/20	50" Flat Back Brolly with zips



THE 50" FLAT BACK BROLLY WITH ZIPS FEATURES A ZIP EITHER SIDE FOR CONVENIENT POLE SHIPPING

50" FIBREGLASS FLAT BACK BROLLY

Based on the legendary Flat Back Brolly, this new version has lighter fibreglass arms and a 210D waterproof nylon cover with taped seams.

- Lightweight fibreglass arms
- Waterproof taped seams
- Pegging points
- Angle tilt
- Pegs supplied
- Storage sleeve

TRADE QTY	2
-----------	---

CODE	DESCRIPTION
LUG/21	50" Fibreglass Flat back Brolly



UV 50+
ULTRA VIOLET
PROTECTION

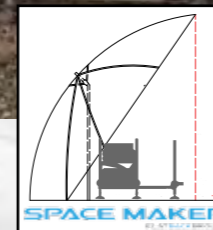
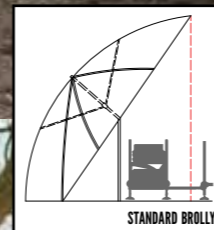

UV 50+
ULTRA VIOLET
PROTECTION

SPACE MAKER FLAT BACK BROLLY

With new short spoke configuration it gives the angler an impressive 20% more coverage ensuring that you and your tackle stay dry. When used with the positive Angle Tilt this also reduces the amount of unused space at the rear of the brolly. Sporting dynamic new graphics the Space Maker also boasts all of the features of our existing umbrella range.

- Lightweight fibreglass arms
- Waterproof taped seams
- Pegging points
- Angle tilt
- Pegs supplied
- Storage sleeve
- UV50 protection

TRADE QTY	1
-----------	---

CODE	DESCRIPTION
LUG/22	Space Maker Flat Back Brolly





MONSTER LUGGAGE

MONSTER® SMALL ROD HOLDALL

Designed to house both rods and poles. The small holdall will comfortably hold six standard rod tubes and features internal elasticated Velcro straps to hold them safely in place. With external umbrella and internal bank stick pockets all storage eventualities are covered and the padded shoulder strap, carry handle and loading handle make transporting the holdall very easy.

FEATURES

- Hardcase Construction and Hardbase
- External umbrella Pocket
- Internal Bankstick Pocket
- Load Handle

W: 20CM H: 188CM D: 14CM

TRADE QTY
1

CODE	DESCRIPTION
PMLUG/01	Small Rod Holdall

MONSTER® LARGE ROD HOLDALL

For transporting poles and rods safely the large holdall will accommodate eight standard rod tubes and features internal elasticated Velcro straps to hold them safely in place. External and internal pockets will house landing net handles, bank sticks and an umbrella and transportation is made simple by utilising the padded shoulder strap, carry handle and loading handle.

FEATURES

- Hardcase Construction and Hardbase
- External umbrella Pocket
- Internal Bankstick Pocket
- Load Handle

W: 26CM H: 188CM D: 16CM

TRADE QTY
1

CODE	DESCRIPTION
PMLUG/02	Large Rod Holdall

RE-DESIGNED TO MEET THE DEMANDING REQUIREMENTS OF MODERN MATCH FISHING.

INNOVATIVE FEATURES, STYLISH NEW COLOUR SCHEME AND ADDITIONS TO THE RANGE MAKE IT THE 'MUST HAVE' LUGGAGE RANGE FOR 2015.

MONSTER® 10 TUBE POLE HOLDALL

Fully padded holdall, designed specifically for housing a pole, complete with extensions and a large selection of top kits and spare sections. Incorporates a concealed side pocket for storing landing net handles, bank sticks and umbrellas and features a clever dual zip system for full length access or top loading only.

FEATURES

- Fully Padded
- Concealed Pocket
- Dual Zip
- Load Handle

W: 26CM H: 193CM D: 18CM

TRADE QTY
1

CODE	DESCRIPTION
PMLUG/03	10 Tube Pole Holdall

MONSTER® DOUBLE HOLDALL

Store up to four ready-made rods and all your pole gear, ideal for festivals or the angler that wants to leave nothing to chance. Comes complete with two removable rod sleeves, which can each hold two readymade rods, and a large rear compartment which will take up to eight standard rod tubes secured with elasticated Velcro straps, ideal for storing poles and top kits. Also features a concealed side pocket and convenient loading handle which makes maneuvering in an out of your vehicle a simple task.

FEATURES

- Padded and Hardcase Construction
- Concealed Pocket
- Load Handle
- Complete with 2 Rod Sleeves

W: 32CM H: 188CM D: 24CM

TRADE QTY
1

CODE	DESCRIPTION
PMLUG/04	Double Holdall





STACK RODS SAFELY AND SECURELY WITHOUT DRAMATICALLY INCREASING THE OVERALL SIZE



MONSTER® 1+1 ROD HOLDALL

A new luggage concept which effectively doubles the storage capacity of a standard single rod holdall with the inclusion of clever internal rod locators and separators.

Now you can quite literally stack two rods safely and securely without dramatically increasing the overall size of the holdall.

- Hardcase Construction with a Hardbase
- Internal Rod Locators
- Padded Reel Separator

160CM W: 15CM H: 163CM D: 12CM

180CM W: 15CM H: 190CM D: 12CM

TRADE QTY

1

CODE	DESCRIPTION
PMLUG/05	160cm 1+1 Rod Holdall
PMLUG/06	180cm 1+1 Rod Holdall

MONSTER® 2+2 ROD HOLDALL

A new luggage concept which effectively doubles the storage capacity of a standard two rod holdall with the inclusion of clever internal rod locators and separators.

Now you can stack four rods safely and securely without dramatically increasing the overall size of the holdall. With an additional external pocket for landing net handles and feeder rests there is no longer a need to carry two holdalls.

- Hardcase Construction with a Hardbase
- Internal Rod Locators and External Pocket
- Padded Reel Separators

160CM W: 22CM H: 163CM D: 15CM

180CM W: 22CM H: 190CM D: 15CM

TRADE QTY

1

CODE	DESCRIPTION
PMLUG/07	160cm 2+2 Rod Holdall
PMLUG/08	180cm 2+2 Rod Holdall



MONSTER® TIP TUBE

The Hardcase Tip Tube provides excellent protection for spare quiver tips. The full length zip gives total access allowing easy selection of tips and prevents delicate guides being damaged when being placed into the tube.

W: 6CM H: 76CM D: 5.5CM

TRADE QTY

1

CODE	DESCRIPTION
PMLUG/18	Tip Tube

PMLUG/18

Tip Tube

FEATURES

- Full Length Zip
- Hardcase Construction
- Will accommodate 20+ tips



MONSTER® TRIPLE ROD HOLDALL

Designed to store and carry three made up rods securely in neat locators, held safely in place by Velcro straps with the added protection of Hardcase material. Incorporates a zipped side pocket that is suitable for storing landing net handles, bank sticks and feeder arms. Suitable for three piece float and feeder rods

- Hardcase Construction
- Internal Rod Locators
- Hardbase
- External Pocket

160CM W: 29CM H: 163CM D: 15CM

180CM W: 29CM H: 190CM D: 15CM

TRADE QTY

1

CODE	DESCRIPTION
PMLUG/09	160cm Triple Rod Holdall
PMLUG/10	180cm Triple Rod Holdall

PMLUG/09

160cm Triple Rod Holdall

PMLUG/10

180cm Triple Rod Holdall



MONSTER

BAGS / CASES



new

new

MONSTER® REEL CASE

A compact and safe way of transporting expensive reels. Featuring a Hardcase design with added padding for maximum protection and a full length zip for trouble free, easy access.

- Hardcase Construction
- Additional Padding
- Compact Design

W: 15CM H: 15CM D: 9CM

TRADE QTY
1

CODE	DESCRIPTION
PMLUG/20	Reel Case

MONSTER® READY REEL CASE

All the benefits of the original Hardcase reel case without having to remove the reel from the rod. The clamp style fit allows it to be located around the rod butt giving maximum protection and the clever line locator prevents damage to your reel line whilst in transit.

- Clamp Style Fitting
- Hardcase Construction and Line Locator

W: 15CM H: 15CM D: 9CM

TRADE QTY
1

CODE	DESCRIPTION
PMLUG/17	Ready Reel Case



new

MONSTER® BAIT BAG

Thermally lined with a wipe clean, solid EVA base, the main compartment will comfortably hold four two-pint bait tubs with space for ice packs and other baits. Designed to keep bait cool and fresh whilst fishing. The large outside pocket is perfect for carrying catapults, pole pots and other bait accessories. The Strap Retainer also allows you to stow away the padded shoulder strap when not in use to avoid mud and rain.

- Thermally Lined
- Padded Shoulder Strap
- Strap Retainer
- 1x Large External Pocket

W: 34CM H: 26CM D: 23CM

TRADE QTY
1

CODE	DESCRIPTION
PMLUG/15	Bait Bag



new

MONSTER® TRIPLE NET BAG

With one large, lined, waterproof compartment that will easily accommodate three keepnets and landing nets, this is the bag for the serious commercial angler. There are two additional outside pockets which can be used to store OffBox side trays, riddles and other bulky items. The Strap Retainer also allows you to stow away the padded shoulder strap when not in use to avoid mud and rain.

- Large Waterproof Compartment and 2x External Pockets
- Padded Shoulder Strap
- Strap Retainer

W: 51CM H: 49CM D: 28CM

TRADE QTY
1

CODE	DESCRIPTION
PMLUG/14	Triple Net Bag



new

MONSTER® CARRYALL

Traditional style carryall with robust, wipe clean hardbase. The large main compartment has a 55 litre capacity, big enough to carry all large accessories. There are also four outside pockets - two zipped end-pockets (ideal for clothing) and two full-sized net and side tray pockets. The Strap Retainer also allows you to stow away the padded shoulder strap when not in use to avoid mud and rain.

- Hardbase
- 55 Litre Main Compartment and 4 External Pockets
- Padded Shoulder Strap and Strap Retainer

W: 60CM H: 47CM D: 43CM

TRADE QTY
1

CODE	DESCRIPTION
PMLUG/11	Carryall



new

MONSTER® MEGA BAIT BAG

Has a large insulated main compartment big enough to accommodate a vast array of baits and bait accessories. There's also a spacious outer pocket. The bag boasts a sturdy wipe clean Hardbase and padded carry handle for easy transportation. The Strap Retainer also allows you to stow away the padded shoulder strap when not in use to avoid mud and rain.

- FEATURES
- Insulated Main Compartment
 - Padded Shoulder Strap
 - Strap Retainer
 - 1x Large External Pocket
 - Hardbase

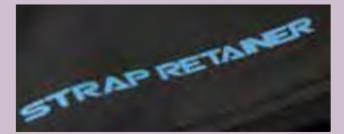

W: 52CM H: 31CM D: 33CM

TRADE QTY
1

CODE	DESCRIPTION
PMLUG/16	Mega Bait Bag



new

INCLUDES
ACCESSORY POUCHES
& STORAGE BOX

MONSTER® FEEDER & ACCESSORY BAG

Designed to accommodate a large selection of feeders and terminal tackle. Complete with two generously sized pouches for feeders and leads and a handy tackle box for accessories and floats. The outer pockets will accommodate InBox Hooklength Retainers and the Strap Retainer allows you to stow away the padded shoulder strap when not in use to avoid mud and rain.

- Includes 2 accessory pouches and tackle storage box
- Padded Shoulder Strap and Strap Retainer with 3x External Pockets

W: 43CM H: 23CM D: 34CM

TRADE QTY
1

CODE	DESCRIPTION
PMLUG/13	Feeder & Accessory Bag



new

MONSTER® TACKLE & ACCESSORY BAG

This innovative lay-flat design carryall has two fold out compartments at the top designed to take two rollers, along with pole supports and other OffBox attachments. The large base compartment will accommodate bait or larger tackle items and provides enough storage space for even the most serious angler. The Strap Retainer also allows you to stow away the padded shoulder strap when not in use to avoid mud and rain.

- Lay-Flat Style Design with Large Capacity Compartments
- Padded Shoulder Strap and Strap Retainer

W: 57CM H: 40CM D: 33CM

TRADE QTY
1

CODE	DESCRIPTION
PMLUG/12	Tackle and Accessory Bag

MONSTER® ROLLER AND ROOST BAG

Accommodates 2 large V Rollers or 2 Flat Rollers as well as all of your pole roosts, tripods and spare seatbox legs. Perfect for storing all of those large, extra long accessories that you can't fit into a standard carryall. The additional large front pocket is ideal for housing long hooklength boxes and other accessories. The Strap Retainer also allows you to stow away the padded shoulder strap when not in use to avoid mud and rain.

W: 84CM H: 13CM D: 25CM

TRADE QTY
1

CODE	DESCRIPTION
PMLUG/19	Roller and Roost Bag



new

EVA BAGS/CASES



MONSTER® EVA NET BAG

This extra large, fully waterproof EVA bag has been designed for the match angler requiring up to four keepnets. Will also accommodate landing nets and side trays, including the Mega Side Tray. The innovative design features plugs in the base for easy draining of retained water. Complete with heavy duty carry handles and shoulder strap.

W: 600MM H: 660MM D: 260MM

TRADE QTY	
1	

CODE	DESCRIPTION
EVA/03	Monster® EVA Net Bag



MONSTER® EVA GROUNDBAIT BOWLS

A range of carefully sized square groundbait bowls, constructed from a durable, waterproof EVA material. Perfect for containing your mixed groundbait or prepared pellets on a side tray.

TRADE QTY	
1	

CODE	DESCRIPTION
EVA/04	3 Litre Bait Bowl
EVA/05	5 Litre Bait Bowl
EVA/06	12 Litre Bait Bowl



MONSTER® EVA BAIT AND TACKLE BAG

The ideal storage solution for all your tackle and bait. Also perfect for storing your waterproof clothing and boots.

W: 500MM H: 300MM D: 300MM

TRADE QTY	
1	

CODE	DESCRIPTION
EVA/11	Monster EVA Bait and Tackle Bag



A RANGE OF EVA ACCESSORY CASES WITH CLEAR LIDS FOR EASY TACKLE IDENTIFICATION. PERFECT FOR ORGANISING AND STORING CAD POTS, CATAPULTS, OFFBOX ACCESSORIES AND VARIOUS OTHER ITEMS OF TACKLE.

MINI MONSTER® EVA SMALL ACCESSORY CASE

W: 180MM H: 60MM D: 180MM

TRADE QTY	
2	

CODE	DESCRIPTION
EVA/07	Mini Monster Small Accessory Case

MINI MONSTER® EVA MEDIUM ACCESSORY CASE

W: 180MM H: 100MM D: 180MM

TRADE QTY	
2	

CODE	DESCRIPTION
EVA/08	Mini Monster Medium Accessory Case

MINI MONSTER® EVA LARGE ACCESSORY CASE

W: 300MM H: 100MM D: 180MM

TRADE QTY	
2	

CODE	DESCRIPTION
EVA/09	Mini Monster Large Accessory Case



MINI MONSTER® EVA DROP BUCKET

When mixing groundbait have you ever struggled to collect water if the bank is too steep or slippery? The Drop Bucket solves the problem with a robust cord and EVA construction.

W: 180MM H: 200MM

TRADE QTY	
2	

CODE	DESCRIPTION
EVA/12	Mini Monster EVA Drop Bucket



MONSTER® EVA METHOD BOWL SET

Purpose designed for all method and feeder requirements. Features a unique zipped EVA bowl, integral plastic mixing bowl and medium sized riddle. Perfect for commercials.

W: 390MM H: 130MM

TRADE QTY	
1	

CODE	DESCRIPTION
EVA/10	Monster EVA Method Bowl Set



STANDARD BAIT BAG

A compact durable, wipe-clean, thermally-lined bait bag with a main compartment and a large outer pocket. Great for all bait requirements.

TRADE QTY	1
-----------	---

CODE	DESCRIPTION
COMPBG/06	Standard Bait Bag

MEGA BAIT BAG

A large, durable, wipe-clean, thermally-lined bait bag with a main compartment and a large outer pocket. The outer pocket is ideal for transporting catapults and hooklength boxes.

TRADE QTY	1
-----------	---

CODE	DESCRIPTION
COMPBG/07	Mega Bait Bag

COMPETITION REEL CASES

Padded compartment for protection, ideally suits match size reels. Suitable for carrying feeders and small accessories.

TRADE QTY	5
-----------	---

CODE	DESCRIPTION
COMPBG/15	Reel Case - Single
COMPBG/16	Reel Case - Double



45 LITRE CARRYALL

Two front and two zipped end pockets. Large main compartment and keepnet compartment. Additional outer pocket for landing nets and bait trays. Over sized zips for increased reliability.

TRADE QTY	1
-----------	---

CODE	DESCRIPTION
COMPBG/01	45L Carryall

55 LITRE CARRYALL

Large capacity carryall with the same design as the 45 litre version. Larger main compartment, keepnet compartment, outer pocket, two zipped end pockets. Padded shoulder strap and over sized zips.

TRADE QTY	1
-----------	---

CODE	DESCRIPTION
COMPBG/02	55L Carryall

COMPETITION

MANUFACTURED FROM A HIGH QUALITY, WIPE CLEAN FABRIC, THE COMPETITION MATCH LUGGAGE HAS BEEN DESIGNED BY PRESTON INNOVATIONS TO PERFORM TO THE HIGHEST STANDARDS, WITH THE EMPHASIS ON QUALITY



DOUBLE NET BAG

Two large main compartments for keepnets and two smaller outer pockets for bait trays, riddles etc. The over sized zips offer increased reliability.

TRADE QTY	1
-----------	---

CODE	DESCRIPTION
COMPBG/08	Competition Double Net Bag

SINGLE NET BAG

Simple keepnet bag with main zipped compartment designed to accommodate a keepnet and landing net. Also features an outer pocket, ideal for side trays and bait waiters.

TRADE QTY	1
-----------	---

CODE	DESCRIPTION
COMPBG/19	Competition Single Net Bag

EVA NET BAG

Manufactured from waterproof EVA, with fully welded seams, this is perfect for transporting wet nets. Featuring a zip top, carry handles and an adjustable shoulder strap, this bag will hold two keepnets and two landing net heads.

TRADE QTY	1
-----------	---

CODE	DESCRIPTION
EVA/01	EVA Net Bag

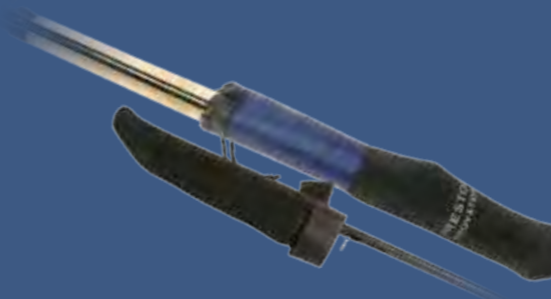

ROD TIP PROTECTORS

Designed to protect the ends of made-up rods in transit. The base sleeve has an adjustable cord for tightening whilst the tip sleeve has a Velcro tightening strap.

TRADE QTY	5
-----------	---

CODE	DESCRIPTION
COMPBK/14	Rod Tip Protectors

6/8/10/12 TUBE HOLDALL

Zippered to the base to allow easy access to the main compartment, which has elasticated straps to hold tubes or poles. Large 3/4 pocket for brollys and landing net handles plus a shorter outside bankstick pocket with reinforced base.

- Full length zip for easy access to the main compartment
- High quality oversized zips and tags
- Reinforced base for durability
- Durable wipe clean fabric

TRADE QTY	1
-----------	---

CODE	DESCRIPTION
COMPBG/18	6 Tube Holdall
COMPBG/03	8 Tube Rod Holdall
COMPBG/04	10 Tube Rod Holdall

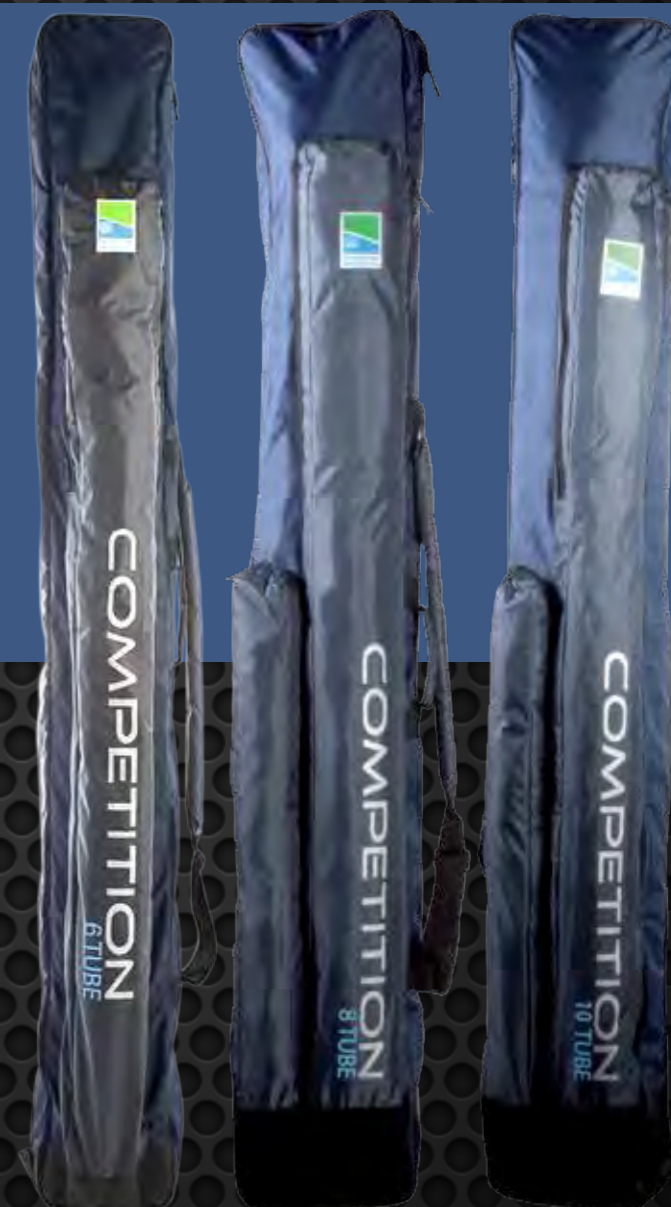

MIX 'N' MATCH

DF20 AND DF12 BIB & BRACE AND JACKETS ARE AVAILABLE TO PURCHASE SEPARATELY ENABLING YOU TO MIX AND MATCH SIZES TO ENSURE THE PERFECT FIT

SIZES

PRESTON TRACK SUIT TROUSERS

	M	L	XL	XXL
WAIST - cms	76 - 80	80 - 86	90 - 96	100 - 106
WAIST - inches	30 - 32	32 - 34	36 - 38	40 - 42
INSIDE LEG - cms	76	77	78	79
INSIDE LEG - inches	30	30	31	31

PRESTON FLEECE JACKETS (ALL)

	M	L	XL	XXL
CHEST - cms	100 - 106	112 - 118	122 - 128	132 - 138
CHEST - inches	40 - 42	44 - 46	48 - 50	52 - 54

PRESTON HOODIES (ALL)

	M	L	XL	XXL
CHEST - cms	100 - 106	112 - 118	122 - 128	132 - 138
CHEST - inches	40 - 42	44 - 46	48 - 50	52 - 54

PRESTON WATER PROOF JACKETS (ALL)

	M	L	XL	XXL	XXXL
CHEST - cms	100 - 106	112 - 118	122 - 128	132 - 138	142 - 148
CHEST - inches	40 - 42	44 - 46	48 - 50	52 - 54	56 - 58

PRESTON WATER PROOF TROUSERS + BIB AND BRACES (ALL)

	M	L	XL	XXL	XXXL
WAIST - cms	76 - 80	80 - 86	90 - 96	100 - 106	114 - 120
WAIST - inches	30 - 32	32 - 34	36 - 38	40 - 42	44 - 48
INSIDE LEG - cms	72	74	76	77	77
INSIDE LEG - inches	28	29	30	30	30



DF20 GILET

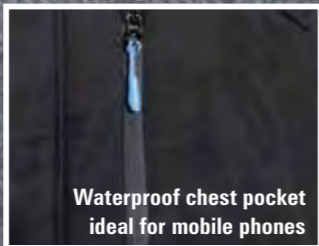

BREATHABILITY 3000mm RATING

WINDPROOF **BREATHABLE**

DF20 GILET

Perfectly complementing the DF20 suit the Gilet provides warmth and increased mobility when worn in conjunction with the bib & brace and the ultimate winter combination when layered up with the complete suit.

FEATURES

- Waterproof chest pocket ideal for your mobile phone
- High collar and fleece lined for comfort
- Wear in conjunction with DF20 Bib and Brace for maximum protection
- Classic bodywarmer styling for increased mobility whilst fishing

TRADE QTY	
1	

CODE	DESCRIPTION
DF20G/M	DF20 Gilet - Medium
DF20G/L	DF20 Gilet - Large
DF20G/XL	DF20 Gilet - XL
DF20G/XXL	DF20 Gilet - XXL

Adjustable storm hood with stiffened peak. Can be concealed within collar



Wide opening leg bottoms allow for quick changes

WATERPROOF 20000mm RATING **BREATHABILITY 3000mm RATING**

WATERPROOF **WINDPROOF** **BREATHABLE**



DF20 SUIT

Constructed from our highest ever specification waterproof material and designed to give maximum protection from the elements. Reinforced in all the key areas and with careful thought put into the seam positioning you can be assured that the DF20 will keep you both dry and comfortable.

JACKET FEATURES

- Ideal length for easy movement whilst seated
- High neck for maximum protection from the elements
- Reinforced shoulders for maximum comfort when carrying tackle
- Storm flaps over the main zips and pockets to protect you from the elements
- Neoprene cuffs to keep out water and draughts
- Waterproof hood with a stiffened peak to offer great protection from the wind and rain
- Zip pullers to make operation with cold hands easy

BIB N BRACE

- Reinforced knee and seat panels
- Storm flap over front double zip
- Wide opening legs with Velcro adjustment
- Wide adjustable shoulder straps with elasticated back for added comfort
- Zip pullers to make operation with cold hands easy

TRADE QTY	
1	

CODE	DESCRIPTION	
DF20/M	DF20 Suit - Medium	40" / 42" Chest
DF20/L	DF20 Suit - Large	44" / 46" Chest
DF20/XL	DF20 Suit - XL	48" / 50" Chest
DF20/XXL	DF20 Suit - XXL	52" / 54" Chest
DF20/XXXL	DF20 Suit - XXXL	56" / 58" Chest

*PLEASE NOTE THAT MIXED SIZE SUITS ARE SUBJECT TO SINGLE ITEM PRICE STRUCTURE

JACKET ONLY

TRADE QTY	
1	

CODE	DESCRIPTION
DF20J/M	Jacket - Medium
DF20J/L	Jacket - Large
DF20J/XL	Jacket - XL
DF20J/XXL	Jacket - XXL
DF20J/XXXL	Jacket - XXXL

BIB & BRACE ONLY

TRADE QTY	
1	

CODE	DESCRIPTION
DF20B/M	Bib & Brace - Medium
DF20B/L	Bib & Brace - Large
DF20B/XL	Bib & Brace - XL
DF20B/XXL	Bib & Brace - XXL
DF20B/XXXL	Bib & Brace - XXXL



Jackets have high collars with velcro closure for protection

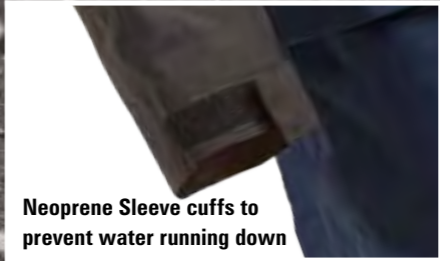

Neoprene Sleeve cuffs to prevent water running down



Wide, adjustable, elasticated straps



Quality zips are covered by storm flaps for added water protection



new

DF12

DF12 SUIT

The DF12 Suit offers the angler a lightweight alternative to the top of the range DF20. Whilst the material is more supple it maintains all of the necessary waterproof qualities and a host of features.

JACKET FEATURES

- Ideal length for easy movement whilst seated
- High neck for maximum protection from the elements
- Reinforced shoulders for maximum comfort when carrying tackle
- Storm flaps over the main zips and pockets to protect you from the elements
- Neoprene cuffs to keep out water and draughts
- Waterproof hood with a stiffened peak to offer great protection from the wind and rain
- Zip pullers to make operation with cold hands easy

BIB N BRACE FEATURES

- Reinforced knee and seat panels
- Storm flap over front double zip
- Wide opening legs with Velcro adjustment
- Wide adjustable shoulder straps with elasticated back for added comfort
- Zip pullers to make operation with cold hands easy



TRADE QTY
1

CODE	DESCRIPTION	
DF12/M	DF12 Suit - Medium	40" / 42" Chest
DF12/L	DF12 Suit - Large	44" / 46" Chest
DF12/XL	DF12 Suit - XL	48" / 50" Chest
DF12/XXL	DF12 Suit - XXL	52" / 54" Chest
DF12/XXXL	DF12 Suit - XXXL	56" / 58" Chest

***PLEASE NOTE THAT MIXED SIZE SUITS ARE SUBJECT TO SINGLE ITEM PRICE STRUCTURE**

JACKET ONLY

TRADE QTY
1

CODE	DESCRIPTION
DF12J/M	Jacket - Medium
DF12J/L	Jacket - Large
DF12J/XL	Jacket - XL
DF12J/XXL	Jacket - XXL
DF12J/XXXL	Jacket - XXXL

BIB & BRACE ONLY

TRADE QTY
1

CODE	DESCRIPTION
DF12B/M	Bib & Brace - Medium
DF12B/L	Bib & Brace - Large
DF12B/XL	Bib & Brace - XL
DF12B/XXL	Bib & Brace - XXL
DF12B/XXXL	Bib & Brace - XXXL

MIX 'N' MATCH

DRIFISH™
WATERPROOF 12000mm RATING
BREATHABILITY 3000mm RATING



WATERPROOF 10000mm RATING

CELSIUS THERMAL SUIT

Totally waterproof and seriously hot, the Drifish Celsius range is the warmest angling clothing you're ever likely to see ... or need.

With top quality manufacture throughout, the extremely durable Celsius range is designed for fishing in the coldest conditions, the thermal 'hollofil' lining traps your body heat with maximum efficiency, yet doesn't impede movement. In fact the Celsius is so warm you only need a minimum of additional clothing underneath it.

Combine the three-quarter length Jacket and Bib & Brace and you have the ultimate combination for cold conditions.

WATERPROOF RATING: 10000MM

JACKET FEATURES:

- Detachable wire peaked hood
- Velcro storm cuffs
- Waist adjustable
- Large expandable pockets
- High collar with fleece lining

BIB 'N' BRACE FEATURES

- Adjustable straps
- Storm sealed zip
- Reinforced knee pads
- Reinforced seat pad
- Warm fleece lined pockets

TRADE QTY
1

CODE	DESCRIPTION
DRIC4/M	Medium
DRIC4/L	Large
DRIC4/XL	XL
DRIC4/XXL	XXL
DRIC4/XXXL	XXXL



CLASH OF THE TITANS

Tommy Pickering and Des Shipp go head to head at one of the UK's top commercial fisheries. An action-packed battle to be the winner.

TRADE QTY
2

CODE	DESCRIPTION
TITANSDVD/01	Clash Of The Titans DVD

ABSOLUTE MATCH FISHING

The double disc, acclaimed TV Series by match anglers, for match anglers. Over 3 hours of footage.

TRADE QTY
1

CODE	DESCRIPTION
ABMFDVD/01	Absolute Match Fishing DVD



POLARISED SUNGLASSES

Available in sport (plastic frame) or classic (metal frame). Supplied with a hard case.

TRADE QTY
1

CODE	DESCRIPTION
PGLASS/01	Sport Grey (Plastic Framed)
PGLASS/02	Sport Brown (Plastic Framed)
PGLASS/03	Classic Grey (Metal Framed)
PGLASS/04	Classic Brown (Metal Framed)

PRESTON TOWEL

A must-have, handy sized towel, back by overwhelming public demand. Ideal product to keep your hands clean and dry when out on the bank.



TRADE QTY
3

CODE **DESCRIPTION**

PTOWEL Towel



DRIFISH
PERFORMANCE FISHING CLOTHING

DRIFISH NECK WARMER

Made from windproof fleece, it is worn around the neck and eliminates heat loss from the neck area in winter.

TRADE QTY
5

CODE **DESCRIPTION**

DRI/NW Drifish Neck Warmer

PRESTON 2 PIECE UNDERWEAR

Soft microfleece fabric retains heat whilst wicking away moisture. For maximum performance wear as a base layer next to the skin. When worn as part of a layered thermal system, this will dramatically increase your comfort levels.



TRADE QTY
1

CODE **DESCRIPTION**

PDR12/M Medium

PDR12/L Large

PDR12/XL XL

PDR12/XXL XXL

PDR12/XXXL XXXL



MICROFLEECE

Provides a lightweight and effective level of insulation, can be used as an outer layer in cool conditions or as a base layer during the winter months.

TRADE QTY
1

CODE **DESCRIPTION**

PMFLEECE2/M Medium

PMFLEECE2/L Large

PMFLEECE2/XL XL

PMFLEECE2/XXL XXL



WINDPROOF HOODED FLEECE JACKET

Made from windproof breathable fleece which is ideal outer wear in dry weather. Also suitable for building up warm layers under waterproof clothing. Features draw cord waist and elasticated cuffs keep to the wind out and two zipped side pockets and a zipped chest pocket.

TRADE QTY
1

CODE **DESCRIPTION**

FJACK16/M Medium

FJACK16/L Large

FJACK16/XL XL

FJACK16/XXL XXL



PRESTON HOODED FLEECE

A practical, warm, lined pullover fleece which can be worn as an outer layer in warmer weather or as part of a layer system under waterproof clothing. This two tone fleece features two side pockets a drawstring hood and a quarter zip.

TRADE QTY
1

CODE **DESCRIPTION**

PFLEECE3/M Medium

PFLEECE3/L Large

PFLEECE3/XL XL

PFLEECE3/XXL XXL



SOFT SHELL JACKET

With a high collar to reduce drafts, this jacket offers fantastic protection and warmth from the wind whilst fishing. Features Velco cuffs and mobile phone pocket.

TRADE QTY
1

CODE **DESCRIPTION**

FJACK17/M Medium

FJACK17/L Large

FJACK17/XL XL

FJACK17/XXL XXL



TRACKSUIT TROUSERS

Lightweight and comfortable, they make the perfect base layer during winter and are perfect during the warm months.

TRADE QTY
1

CODE **DESCRIPTION**

PTRACK/M Medium

PTRACK/L Large

PTRACK/XL XL

PTRACK/XXL XXL



TRACKSUIT JACKET

Featuring the same classy livery and zipped pockets as the matching trousers, it is ideal summer or casual wear for the fashion conscious angler.

TRADE QTY
1

CODE **DESCRIPTION**

PTRACKJ/M Medium

PTRACKJ/L Large

PTRACKJ/XL XL

PTRACKJ/XXL XXL

DRIFISH
PERFORMANCE FISHING CLOTHING



DRIFISH TROUSERS

Manufactured from lightweight, hard-wearing material, reinforced in the knee and seat areas with adjustable ankle and waist. Waterproof and breathable.

TRADE QTY
1

CODE **DESCRIPTION**

DRITR/M Medium

DRITR/L Large

DRITR/XL XL

DRITR/XXL XXL

DRIFISH
PERFORMANCE FISHING CLOTHING



DRIFISH BIB & BRACE

Manufactured from a hard wearing, lightweight material. Reinforced in the knee and seat areas for increased durability, features adjustable ankles and elasticated waist. Waterproof and breathable.

TRADE QTY
1

CODE **DESCRIPTION**

DRIB/M Medium

DRIB/L Large

DRIB/XL XL

DRIB/XXL XXL



PRESTON JOGGERS

Medium weight, featuring zipped side pockets, elasticated ankles and a draw cord waist. They are warm, stylish and comfortable, perfect for long sessions sat on your seatbox.

TRADE QTY
1

CODE **DESCRIPTION**

PJOG1/M Navy - Medium

PJOG1/L Navy - Large

PJOG1/XL Navy - XL

PJOG1/XXL Navy - XXL

PJOG2/M Black - Medium

PJOG2/L Black - Large

PJOG2/XL Black - XL

PJOG2/XXL Black - XXL

'CASUAL' BLACK HOODIE

Medium-weight cotton rich hoody featuring. Contrasting hood inner and drawstrings with printed logo to right arm.

TRADE QTY	
1	

CODE	DESCRIPTION
PHD3/M	Medium
PHD3/L	Large
PHD3/XL	XL
PHD3/XXL	XXL

'ROYAL' BLUE HOODIE

Featuring a contemporary print on a quality cotton rich medium weight hoody with contrasting hood inner and drawstrings.

TRADE QTY	
1	

CODE	DESCRIPTION
PHD1/M	Medium
PHD1/L	Large
PHD1/XL	XL
PHD1/XXL	XXL

'TOP GUN' NAVY BLUE HOODIE

Quality hoody featuring printed design and embroidered detail. Hood inner and drawstrings compliment the colour.

TRADE QTY	
1	

CODE	DESCRIPTION
PHD2/M	Medium
PHD2/L	Large
PHD2/XL	XL
PHD2/XXL	XXL



'CASUAL' BLACK T-SHIRT

Smart 100% cotton T-Shirt with understated design and back print.

TRADE QTY	
1	

CODE	DESCRIPTION
PSHIRT12/M	Medium
PSHIRT12/L	Large
PSHIRT12/XL	XL
PSHIRT12/XXL	XXL

'ROYAL' BLUE T-SHIRT

Contemporary design in 100% cotton with subtle embroidered detail.

TRADE QTY	
1	

CODE	DESCRIPTION
PSHIRT10/M	Medium
PSHIRT10/L	Large
PSHIRT10/XL	XL
PSHIRT10/XXL	XXL

'TOP GUN' NAVY BLUE T-SHIRT

Featuring stylish printed design with embroidered detail to sleeve. 100% cotton.

TRADE QTY	
1	

CODE	DESCRIPTION
PSHIRT11/M	Medium
PSHIRT11/L	Large
PSHIRT11/XL	XL
PSHIRT11/XXL	XXL



A RANGE OF CLASSY 100% COTTON POLO SHIRTS FEATURING 3 BUTTON FASTENING AND SMART EMBROIDERED DETAIL

'1985' NAVY BLUE POLO

TRADE QTY	
1	

CODE	DESCRIPTION
PSHIRT14/M	Medium
PSHIRT14/L	Large
PSHIRT14/XL	XL
PSHIRT14/XXL	XXL

'1985' WHITE POLO

TRADE QTY	
1	

CODE	DESCRIPTION
PSHIRT15/M	Medium
PSHIRT15/L	Large
PSHIRT15/XL	XL
PSHIRT15/XXL	XXL

'1985' BLUE POLO

TRADE QTY	
1	

CODE	DESCRIPTION
PSHIRT13/M	Medium
PSHIRT13/L	Large
PSHIRT13/XL	XL
PSHIRT13/XXL	XXL



TRAPPER HAT

Showerproof with a fleece lining. Fold up the sides for normal use or down for maximum warmth.

TRADE QTY
3

CODE	DESCRIPTION
PTHAT4	Trapper Hat

BLACK BEANIE HAT

This contemporary Beanie Hat will keep your head warm in even the coldest conditions. With stylish Preston Innovations logo.

TRADE QTY
5

CODE	DESCRIPTION
PKHAT2	Black Beanie Hat



THERMAL FISHING SOCKS

Will keep your feet warm and comfortable in the most extreme fishing conditions, with expanding, elasticated cuffs which offer support and ensures a secure perfect fit.

TRADE QTY
5

CODE	DESCRIPTION
PTSOCK	Thermal Fishing Socks

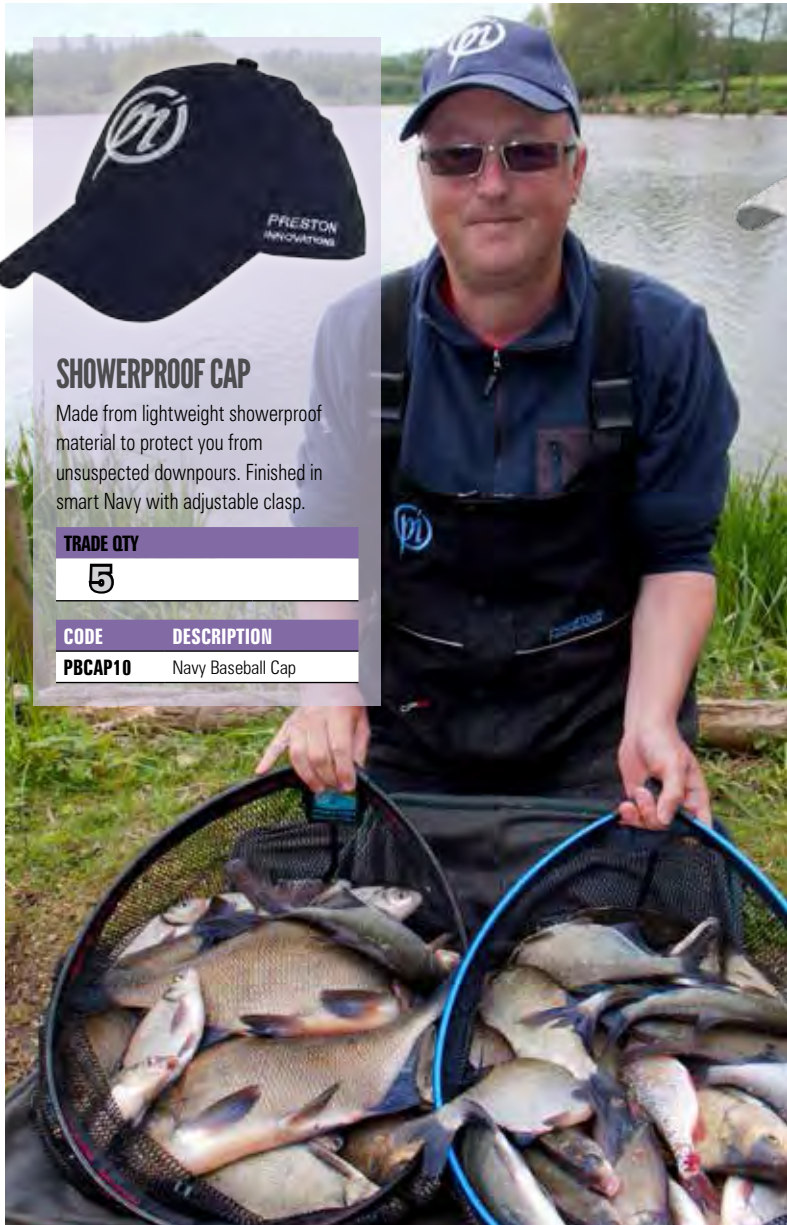

SHOWERPROOF CAP

Made from lightweight showerproof material to protect you from unsuspected downpours. Finished in smart Navy with adjustable clasp.

TRADE QTY
5

CODE	DESCRIPTION
PBCAP10	Navy Baseball Cap



PI LOGO CAPS

Perfect summer caps to keep you cool and keep the sun out of your eyes. Adjustable fitting, one size fits all.

TRADE QTY
5

CODE	DESCRIPTION
PBCAP8	Baseball Cap - White
PBCAP9	Baseball Cap - Black



PRESTON INNOVATIONS CAP

Stylish blue cap with black peak and embroidered logo. The long peak is great for cutting out the glare from the sun.

TRADE QTY
5

CODE	DESCRIPTION
PBCAP3	Navy Baseball Cap