



Innovative Fishing Floats 2012

www.cralusso.com



Károly Králik, leader of Cralusso

When I decided to launch the company Cralusso, I was very aware that I did not just want to produce floats that were amendments and variations of those already available. I knew that I had to think and work in different ways to the norm - "thinking outside the box" if you like - only that would lead to really new designs and true innovation.

I did not want to create just floats but solutions that made easier and more efficient the catching of fish. In the last six years, thanks to these revolutionary designs and solutions, Cralusso has become the leading float developer in the angling industry.

Our products have been successful not only among recreational anglers but at the very highest level of the sport! Top anglers the world over have used our floats to win many high profile competitions.

Main milestones:

- 2002: Launch Cralusso
- 2003: World Championship - Torpedo
- 2005: European Championship - Torpedo
- 2006: Innovation Expo, GENIUS award
- 2007: U.S. Open – Golf and Bubble
- 2008: European Championship - Torpedo
- 2008: U.S. Open - Shark
- 2008: Hungarian National Championship - Shark
- 2009: Best Stand award
- 2010: Sponsorship at Poznan World Cup



In 2009 Cralusso won the prize of „**Best Stand**” under the 30 m² category on the EFTTEX International Fishing Show!

CRALUSSO

The very best choice for professional and recreational anglers alike

A new hydrodynamic form developed by Cralusso, the body does not lift out the water when held back. This float is for use on the pole and is ideal for use in medium or strong flow when you wish to present static or slow moving baits. It is so good and reliable that it has become the number one choice of flat float for anglers of all abilities including a few world champions!

Some quotations about the Torpedo:
 Alan Scotthorne: "The best flat float I've ever used" *Angling Times*, May 10 2005.

Bob Nudd: "It will add a new dimension to your polefishing" *Angling Times* 31 May 2005



Sizes: 0.5 - 0.75 - 1.0 - 1.5 - 2.0 - 3.0 - 4.0 - 5.0 gr

Code: 1001

TORPEDO Tuning



An advanced version of the Torpedo float, which helped the Hungarian team to win gold in the 2003 World Championship. The Torpedo Tuning was also the success story of the 2005 European Championship - 80% of the contestants used our floats, including Will Raison, the individual champion.

As with the Torpedo, this float is for use on the pole and is ideal for use in medium or strong flow when you wish to present static or slow moving baits.

Sizes: 6 - 8 - 10 - 12 - 15 - 20 - 25 - 30 - 40 - 50 gr

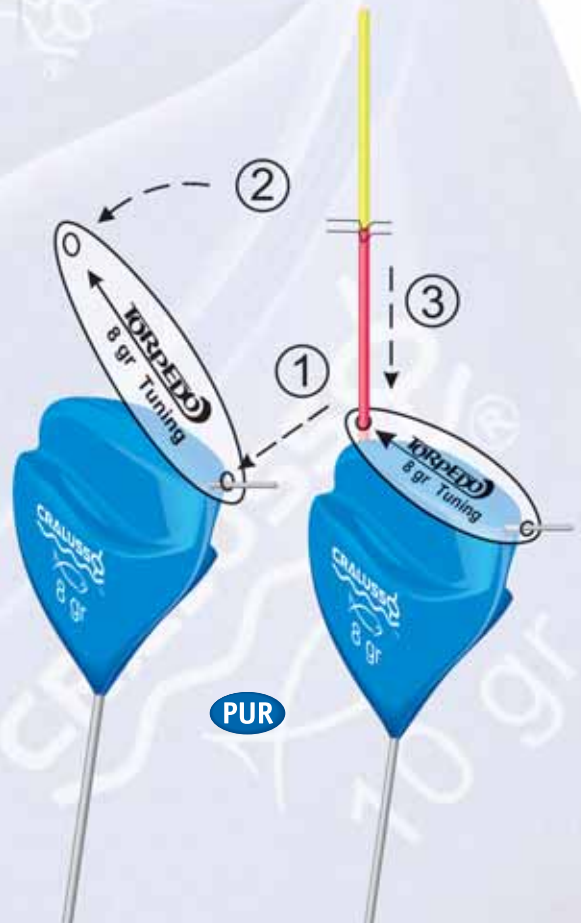

With recommendation of Tibor Ambrus, world champion



Bubble



Code: 1003

A river float designed for use on the pole but has found favour with many anglers on the running line. It is ideal for running through the swim at variable speed. The Bubble was introduced in 2005 Madunice European Championship.

The winner of U.S. Open in 2007 and 2008!

- Variable antenna 1-5 gr 2 pcs
- Variable antenna 6-20 gr 5 pcs
- Waterproof polyurethane body
- Floats can be changed without dismantling the rig

Sizes:
1 - 1,5 - 2 - 3 - 4 - 5 - 6 - 8 - 10 - 12 - 15 - 20 gr



The next step of success!
József Papp won the 2008 U.S. open using a Cralusso Bubble

SHARK

Functions of two floats in one 2 in 1 Code: 1004

- 1 You should use the first antenna position when you are holding the float back hard or even lightly.
- 2 You should use the second antenna position when you want the float running through the swim

Sizes:
1 - 1,5 - 2 - 3 - 4 - 5 - 6
8 - 10 - 12 - 15 - 20 gr

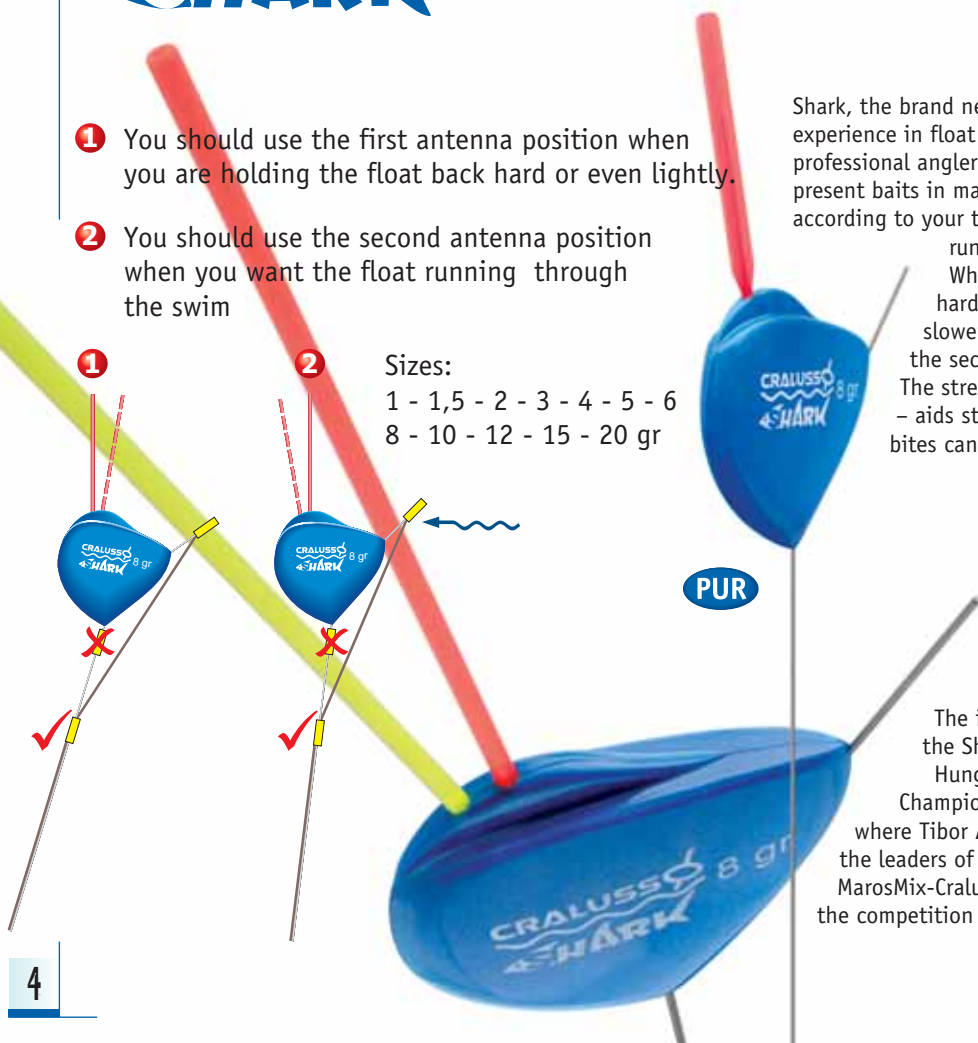

Shark, the brand new flat float was developed using many years of experience in float design and was in response to the demand from professional anglers. Used primarily for pole fishing the float can present baits in many ways. The antenna position can be changed according to your technique – whether this is holding back hard or running the float through the swim.

When the current is strong or you are holding back hard use the first bristle position. When the flow is slower or you want to run the float through the swim the second bristle position is recommended.

The streamline hump on top of the float – the sharks fin – aids stability and sensitivity – even the smallest of bites can be seen clearly.



The introduction of the Shark was at the Hungarian National Championship in 2008, where Tibor Ambrus, one of the leaders of the Tubertini-MarosMix-Cralusso group won the competition using this new float.

Code: 1027

This hard-wearing polyurethane disc float developed by Cralusso can take the place of traditional balsa models, that can be damaged easily.



PUR

Sizes:
1 - 1,5 - 2 - 3 - 4 - 5 - 6 - 8 - 10 - 12 - 15 - 20 gr

Code: 1002

A special river float for use with rod and reel set ups that can be held back hard without drifting in across the flow. The direction and speed can be changed easily offering perfect and accurate presentation. Ideal for medium and strongly currents although it can be used on still water for predator fishing when you wish to work a baitfish parallel to the bank.



PUR

Sizes:
3 - 4 - 6 - 8 - 10 - 12 - 15 - 20 gr

A river float for use Bolognese rods and any running line set up. The design allows you to hold the float back without it drifting in across the flow. You can vary the speed of travel easily, but in sufficient flow and by holding back hard it is possible to lead the Bolo out from the bank toward features, cover or your feed line. You can effectively position the float before letting it run through the swim.



Code: 1005



PUR

Sizes:
3 - 4 - 6 - 8 - 10 - 12
15 - 20 gr

Revolutionary new waggler designs from Cralusso

ROCKET

Code: 1006



We developed the Rocket for long, accurate, straight casting. The Rocket has unique features that enable it to fly much better than traditional wagglers - even those with flights

- 1
- 2
- 3
- 4

Thanks to the versatile and adaptable antenna system, twenty Cralusso sight tips can be used with this float. Three tips are contained in each pack.

The critical element of the Rocket design is the special attachment system. This ensures the optimum position of the float and the terminal tackle it is 'towing' during flight - thus ensuring maximum distance and accuracy is achieved.

When you use this floats after casting you should hold back the float before it falls down into the water to eliminate the possibility of tangles.

By sliding the tube to calibrate the float you can minutely adjust the weighting.

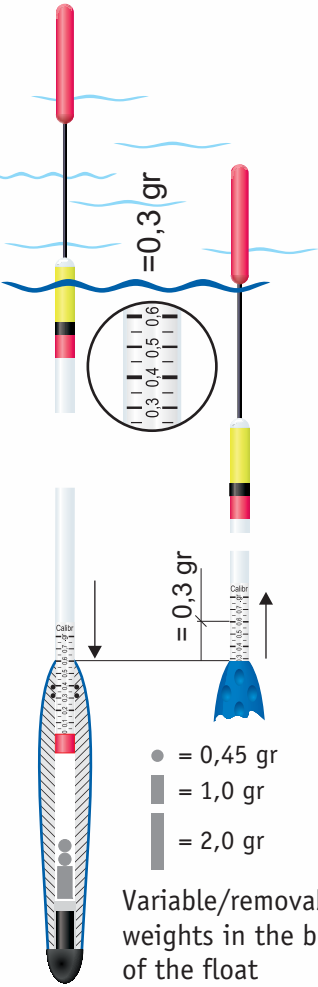

The stem of the float is made from a material that is very strong and will remain straight without becoming twisted or curved.

The calibration system helps quick, simple and accurate adjustments. with 0,05 gr graduations being possible

The aerodynamics are improved with surface indentations (as on a golf ball) which reduces air resistance and increases stability.

1

2

3

PUR

Size gr	Changeable weight
6	2,0 gr
8	2,5 gr
10	3,0 gr
12	3,0 gr
14	3,0 gr
16	3,5 gr
18	3,5 gr
20	3,5 gr

Recommended float adaptors:
Anti tangle waggler attachment
Size: Small, Medium
Code: 2006

How to use this attachment?

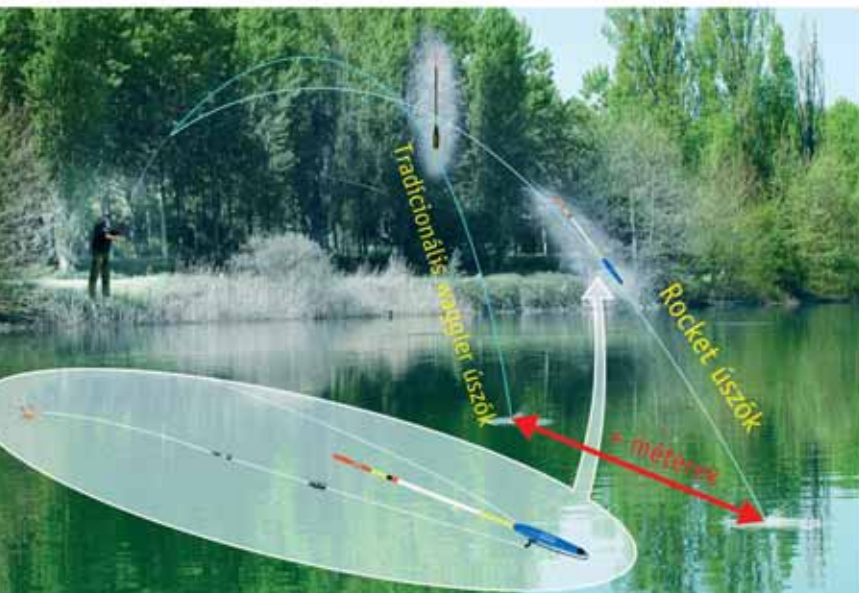
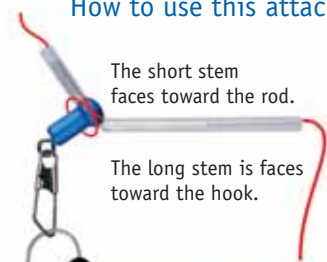



Code: 1007

The UFO waggler is attached in the traditional way but the design incorporates several innovative features.

- 1
- 2
- 3
- 4

The polyurethane body is not sensitive to surface damage and will not allow water ingress. The UFO is a versatile waggler for both pleasure and match anglers alike.

Size gr	Changeable weight
6	2,5 gr
8	3,0 gr
10	3,0 gr
12	3,0 gr
14	3,5 gr
16	3,5 gr
18	4,5 gr
20	5,5 gr



Recommended float adaptors
 Waggler Attachment Light: 2005
 Brass Head Safety Snap: 2122
 Plastic head swivel with interlock snap: 2123



Code: 1014



This model – Rocket Light – has an extraordinary flying ability. While retaining incredible accuracy it is possible, because of the attachment system, to cast 20-30% longer distances than with traditional floats.

Size gr	Changeable weight
1,5	1,0 gr
2,0	1,0 gr
2,5	1,0 gr
3,0	1,0 gr
4,0	1,0 gr
5,0	1,0 gr
6,0	1,0 gr
7,0	1,0 gr
8,0	1,0 gr

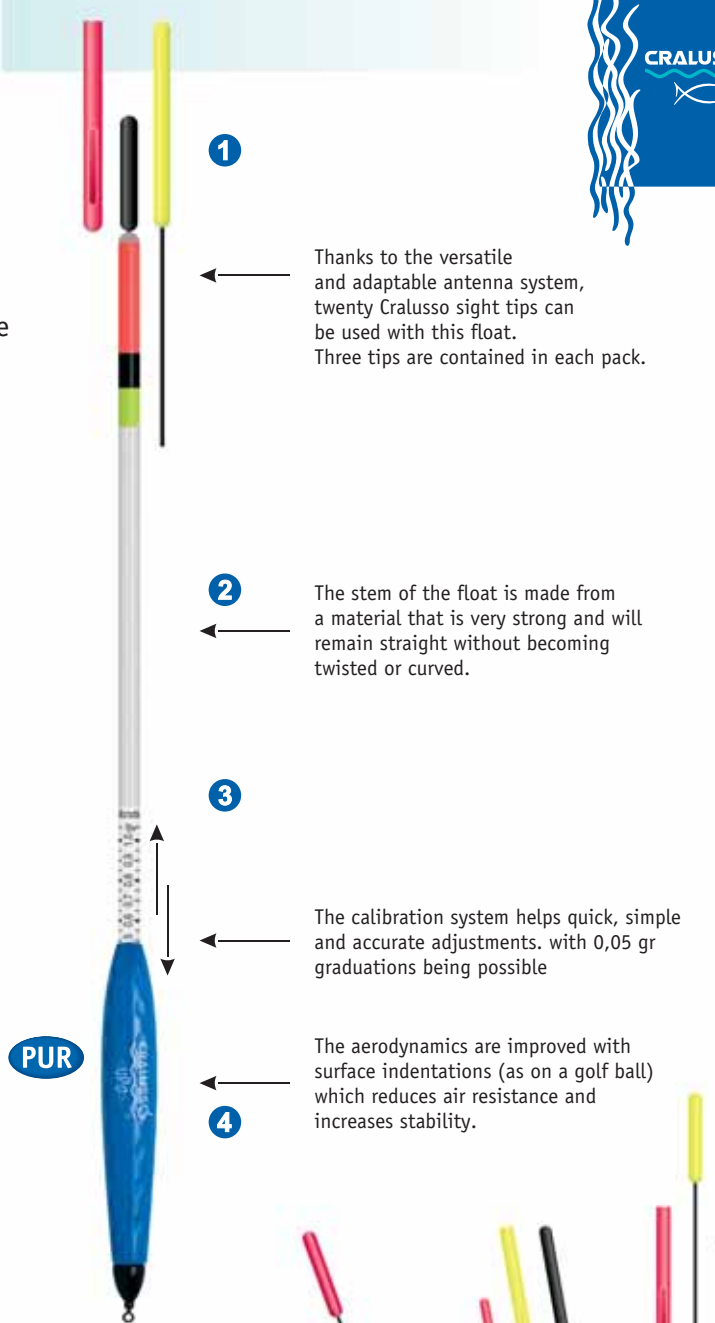

1

Thanks to the versatile and adaptable antenna system, twenty Cralusso sight tips can be used with this float. Three tips are contained in each pack.

2

The stem of the float is made from a material that is very strong and will remain straight without becoming twisted or curved.

3

The calibration system helps quick, simple and accurate adjustments. with 0,05 gr graduations being possible

PUR

4

The aerodynamics are improved with surface indentations (as on a golf ball) which reduces air resistance and increases stability.

Recommended float adaptors:
 Anti tangle waggler attachment
 Size: Small
 Code: 2006

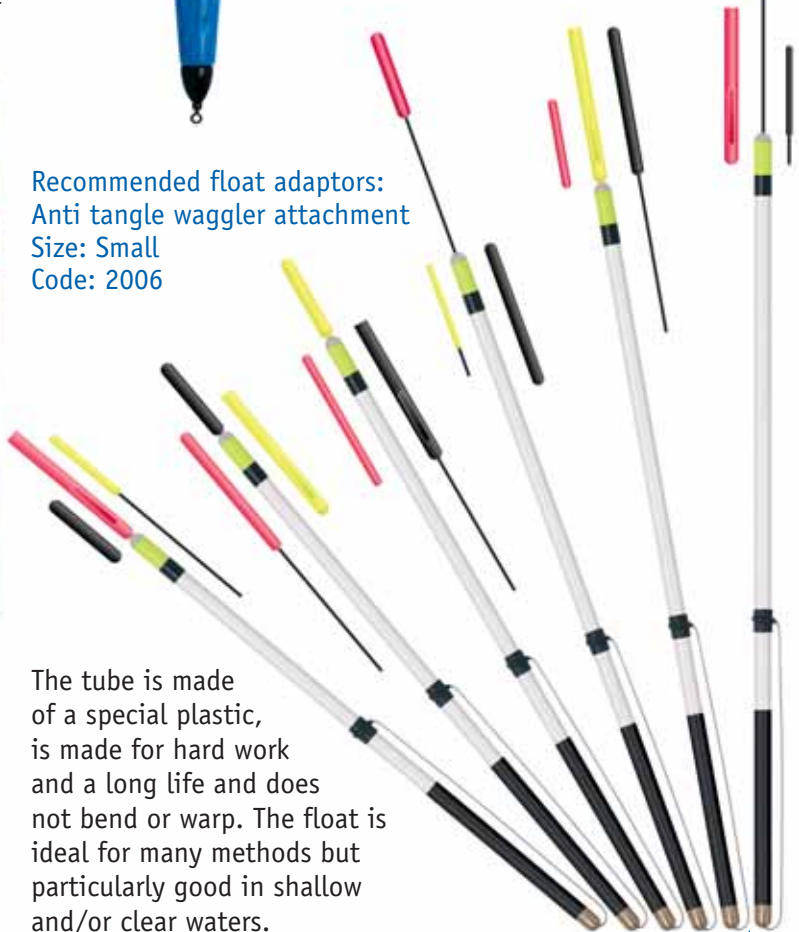

The tube is made of a special plastic, is made for hard work and a long life and does not bend or warp. The float is ideal for many methods but particularly good in shallow and/or clear waters.



Velence

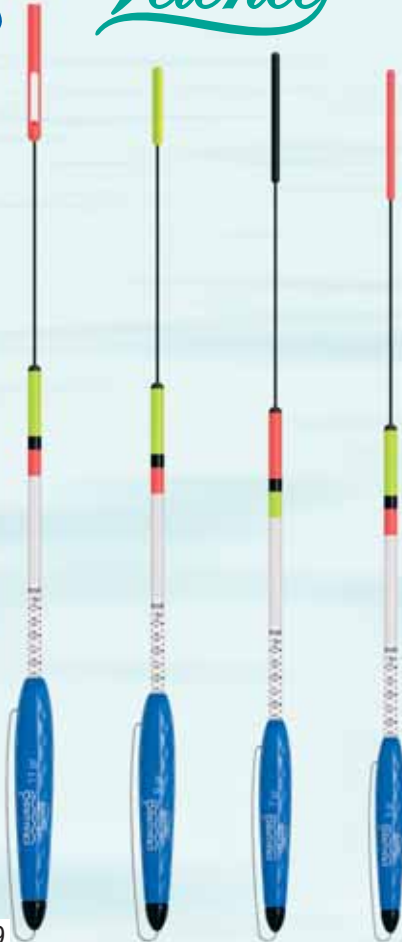

Code: 1009

Sizes: 5 - 7 - 9 - 11 gr



Variable antenna 3 pcs

Sensitive



Code: 1010

Sizes: 5 - 7 - 9 - 11 gr



Variable antenna 2 pcs



Type	Distance of Casting	Changeable weight
Velence 5-11 gr	35-60 m	1,0-2,5 gr
Rocket 6-20 gr	40-85 m	2,0-3,5 gr
Rocket light 1,5-8 gr	20-60 m	+ 1,0 gr
Dart 6-20 gr	35-65 m	2,5-5,5 gr
Sensitive 5-11 gr	35-55 m	1,5-3,0 gr
Ufo 6-20 gr	30-50 m	2,5-5,5 gr

The advantage of these floats is the excellent sensitivity! The Velence and the Sensitive incorporate all of Cralusso's new technical solutions



DART

Code: 1008

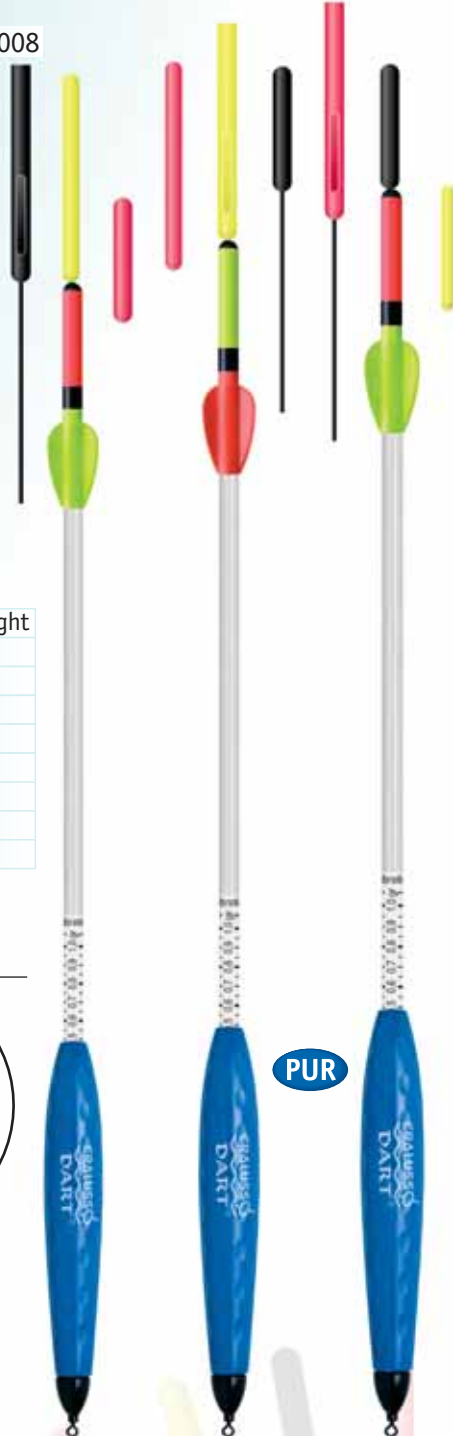

Size gr	Changeable weight
6	2,5 gr
8	3,0 gr
10	3,0 gr
12	3,0 gr
14	3,5 gr
16	3,5 gr
18	4,5 gr
20	5,5 gr

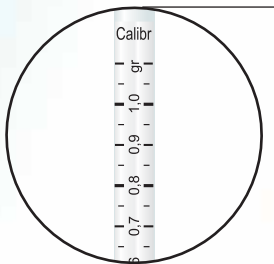

The concept is the same as that found in the UFO waggler but in addition to the other latest developments this version incorporates a flight.

- 1
- 2
- 3

The body is made of polyurethane, which is not sensitive to surface damage. The Dart is a very versatile float, which is a suitable for both pleasure and match anglers alike.

- Recommended float adaptors:
 Waggler Attachment Light: 2005
 Brass Head Safety Snap: 2122
 Plastic head swivel with interlock snap: 2123



ARROW

waggler

Code: 1040



Incorporates a removable brass disc weight system and, of course, all the usual Cralusso innovative features

- 1
- 2
- 3
- 4

With this float we wanted to bring all the features together to create the No.1 very best possible waggler.

The ARROW waggler ensures an aerodynamic flight, high levels of sensitivity and offers a multifunctional, easy to use float.

The longer stem offers the following advantages:

- Generates extraordinary stability and distance in flight
- The body and main weight of the float sits deep in the water and it is therefore less influenced by wind and surface skim
- The long float aids the important task of getting your line deep in the water

Transportation of the long float is not difficult as the stem and body can be separated. This allows the carrying of made up rods where required with no risk of float damage.

Size gr	Changeable weight
8	3,0 gr
10	4,0 gr
12	5,0 gr
14	6,0 gr
16	7,0 gr
18	8,5 gr



ZeroSlider

This float is a new generation Slider with unique design elements and construction

Direction to thread the line



Before casting

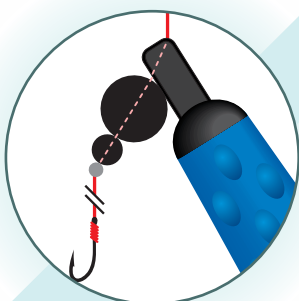

- **0 gramm** is incorporated in the body. This ensures you can use maximum weight down the line and, when necessary, smaller floats can be used.
- It has an outstanding flying ability thanks to the Z shaped line stop system.
- Big casts and efficient fishing are easy with this radical design – problems associated with traditional floats are overcome
- It has the advantages of the brand new development of Cralusso waggler floats. (See: 6. page: 1-2-3)

PUR

When the float is in flight.

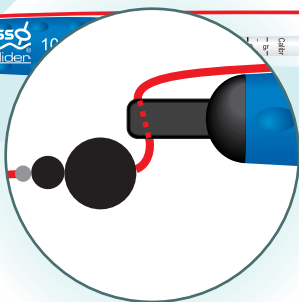

Before casting the float slides down the line to the bulk weight (Cralusso globular weight is suitable – code 3001) and this maintains the distance between float and hooklink.

When the float is in flight the angle of line changes. The special 'Z' fixing system ensures the float is trapped immediately behind the bulk weight. It cannot fly back up the line so good aerodynamics are maintained allowing better distance and accuracy.

When the float lands on the water the angle of line changes again allowing the weight to pull line through the float freely until the bait is positioned perfectly.

In the water

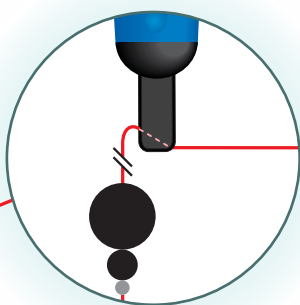

When the float lands on the water

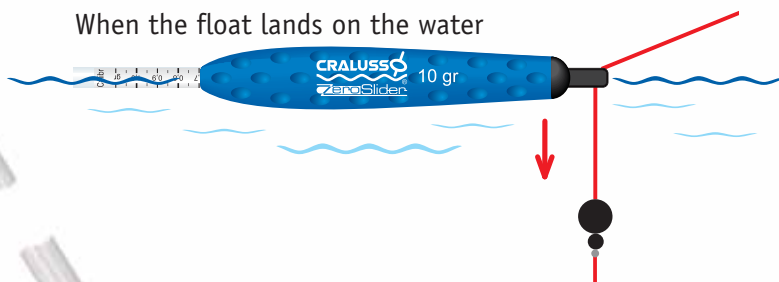

ZeroSlider =

With this slider it is possible to fish further (10-20%) with less tangles and generally more successfully



Variable antenna 2 pcs

Removable head!

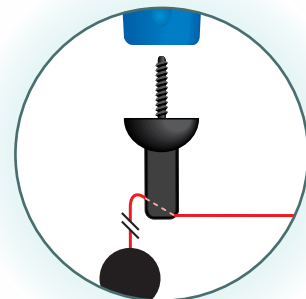

Sizes: 8 - 10 - 12 - 14 - 16 gr

Pellet

This near indestructible float has been made for the ever more popular method of pellet waggler fishing. Being short it can be used successfully when fishing shallow and presenting baits deeper is no problem. You can fish precisely with different sizes and weights of pellet by making adjustments to the capacity of the float using the calibration system.

PUR

Sizes:
S - M - L



Code: 1011

Unweighted slider floats

Code: 1028



Sizes:
3-4-5-6-8 gr

Code: 1029



Sizes:
3-4-5-6-8 gr

Code: 1030

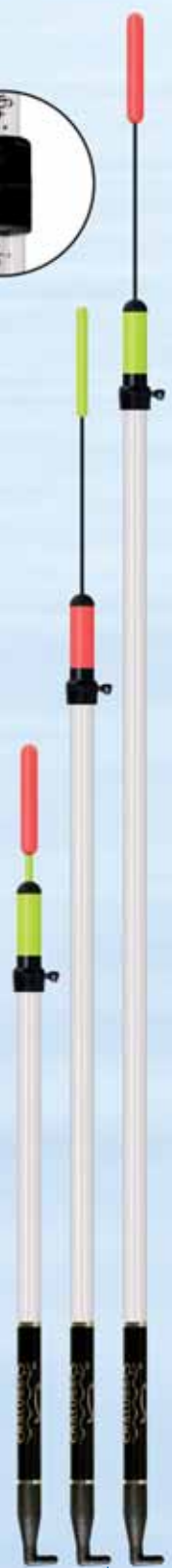

Sizes:
3-4-5-6-8 gr

Rocket Pellet

Code: 1012

This float incorporates all the advantages of the pellet float but also utilises the rocket system.

Normal pellet wagglers are hampered in flight because the float is trying to tow a big bait. Aerodynamics, distance and accuracy are therefore adversely affected.

The Rocket Pellet overcomes all these problems and is the perfect solution – even with heavy reel lines it can cast long distances and is very accurate.

PUR

Sizes:
S - M - L

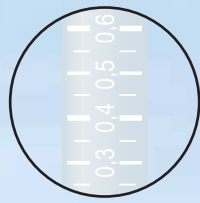

CONTROL MATCH

Code: 1023

Cralusso's newest development is a perfect solution for the problems of many anglers. We have used the very popular calibration system from our bodied wagglers and have also managed to incorporate this system into our revolutionary new straight wagglers. The slim body creates a very sensitive float and the calibration system makes very fast and accurate adjustment possible.



CONTROL MATCH with dart

Code: 1024

The construction of this float is the same as the "Control Match", but we incorporated dart flights into the stem to allow even better flight. The antenna are inter-changeable.

Sizes:

You can adjust the 3-4-5 gr float's loading capacity between 0 and +1,2 gr.

You can adjust the 6-7-8-10 gr float's loading capacity between 0 and +1,5 gr



PRO MATCH

Code: 1025

"Pro Match" floats contain all the useful developments that make the 'Control' version unique. As we have used brass removable heads, it is possible for finer adjustments to be made and for the carrying capacity to be increased still further. It is possible to make very quick, accurate and repeated adjustments by pushing in, or pulling out, the upper, thinner stem from the body of the float.



By sliding the tube to calibrate the float you can minutely adjust the weighting.



PRO MATCH with dart

Code: 1026



The adjustable capacity of the 4 gr float is: between 0 and +2,5 gr
 The 5 gr and 6 gr float is: between 0 and +3,0 gr
 The 7 gr and 8 gr float is: between 0 and +3,5 gr

Reliable floats- even in extreme conditions



Code: 1021

Float with built in weight

Unweighted floats

Code: 1022



When we were creating the traditional type of tear drop floats it was our intention, as is always the company policy, to place the emphasis on making each model easy to use, infinitely variable and long lasting. The design allows all of the components, including the bristles, to be freely interchanged thus allowing numerous combinations to be achieved. The floats are available with carbon stems or a near transparent fibre glass stem that is less visible in water.

Golf

Code: 1015
(fibr glass)
Code: 1018
(carbon)

Spirit

Code: 1016
(fibr glass)
Code: 1019
(carbon)

CAPRI

Code: 1017
(fibr glass)
Code: 1020
(carbon)

Sting

Code: 1050
(fibr. Glass,
fixed antenna)
Code: 1051
(carbon, fixed
antenna)

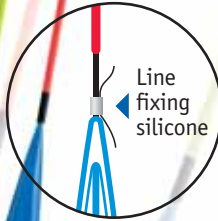

The special dimpled surface of this Golf float, which reduces water tension affects, makes it an ideal choice for use on rivers, moving canals and choppy lakes.

Sizes: 1 - 1.5 - 2 - 3 - 4
5 - 6 - 8 - 10 - 12

Universal shape which is ideal for both rivers and still waters. The protective plastic tube through the float is very hard wearing and makes the float virtually indestructible highly recommended when fishing for carp on the pole.

Sizes: 0,5 - 0,75 - 1
1.5 - 2 - 3 - 4 - 5 - 6

This body shape allows for more sensitive presentation even more so if you use the 1 mm carbon or glass stem as the bristle. Also incredibly strong, however, and will handle big fish well.

Sizes: 0,2 - 0,3 - 0,5 - 0,75 - 1
1.5 - 2 - 3 - 4 - 5 - 6

Our new pole float has a 3D and extremely streamlined shape resulting in exceptional sensitivity and stability.

A hollow, and therefore buoyant, bristle is incorporated in this multifunctional float. It was decided not to use a side eye as these create an inherently weak point but instead of this to utilise a neat silicone sleeve at the base of the antennae.

The body is polyurethane, virtually indestructible and will not absorb water even if you do manage to damage it!

Sizes: 0,5-0,75-1,0-1,25-1,5-2,0 gr

They are well constructed and very strong. Bristles are interchangeable so you can make rigs that perform well for delicate presentation or dealing with big weights of fish.

They can be set up with the line through the body or externally

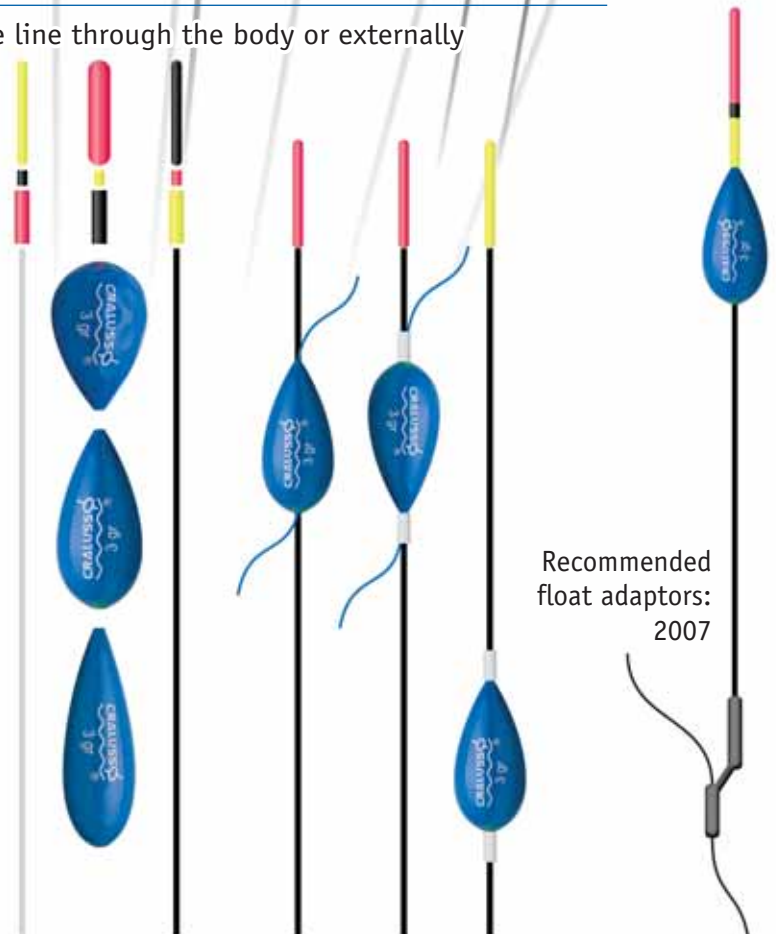
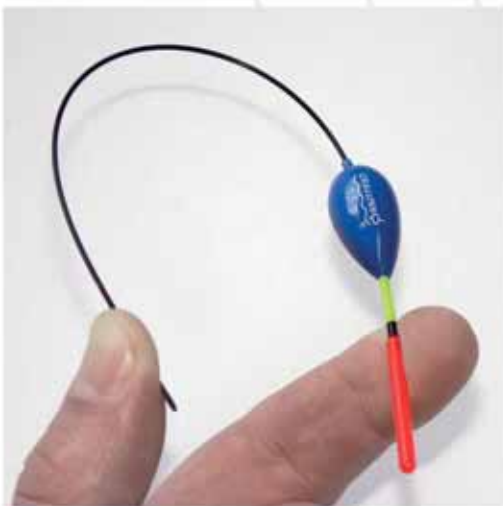

Recommended float adaptors:
2007

Components of the tear drop floats are all interchangeable and they can be assembled in a number of ways to suit your own requirements only your imagination could limit the number of variations.

Balsa floats

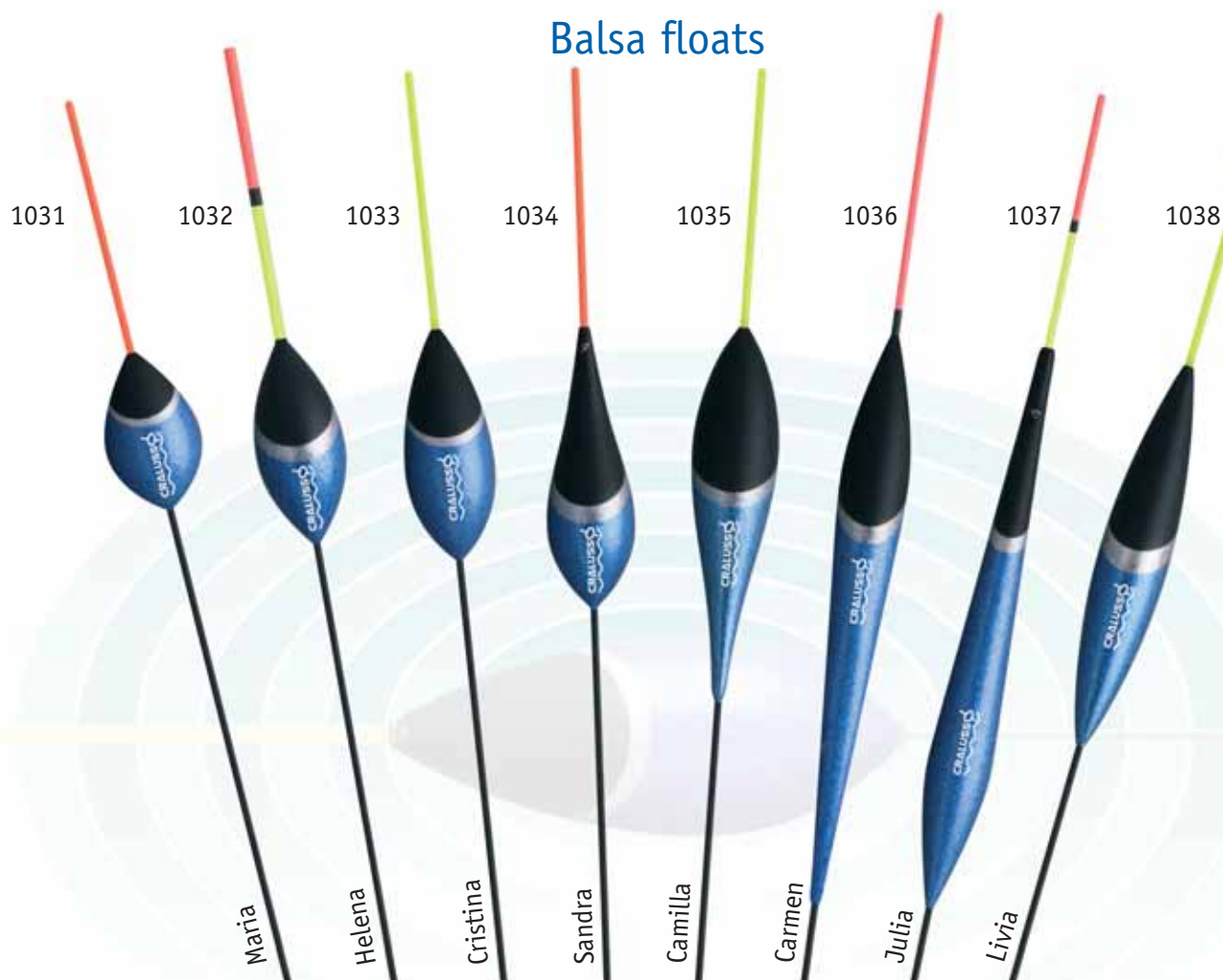

Code	Weight gr	Antenna	Stem	Body mat.	Pcs/bag
1031	1-1,5-2-2,5-3	plastic	metal	balsa	5
1032	0,5-0,75-1-1,5-2-2,5-3	bamboo	metal	balsa	5
1033	0,5-0,75-1-1,25-1,5-1,75-2-2,5-3	plastic	metal	balsa	5
1034	0,25-0,5-0,75-1-1,25-1,5-1,75-2	fibre glass	metal	balsa	5
1035	0,25-0,5-0,75-1-1,25-1,5-1,75-2-2,5-3-4-5-6	fibre glass	fibre glass	balsa	5
1036	0,25-0,5-0,75-1-1,25-1,5-1,75-2-2,5-3	fibre glass	fibre glass	balsa	5
1037	0,5-0,75-1-1,25-1,5-1,75-2-2,5-3	plastic	fibre glass	balsa	5
1038	0,25-0,5-0,75-1-1,25-1,5-1,75-2-2,5-3	fibre glass	fibre glass	balsa	5

Carp Series



Code	Weight gr	Antenna	Stem	Body mat.	Pcs/bag
1070	0,2-0,3-0,5-0,75-1-1,5	variable	carbon	pur	5
1071	0,2-0,4-0,6-0,8-1,0	fix	carbon	balsa	5
1072	0,3-0,5-0,8-1,0	fix	carbon	balsa	5
1073	0,2-0,4-0,6-0,8-1,0	fix	carbon	balsa	5

Float with balsa



Code	Weight gr	Antenna	Stem	Body mat.	Pcs/bag
1041	1-1,5-2-3-4-5-6	plastic	fibre glass	balsa	5
1042	0,5-0,75-1-1,5-2-2,5-3-4-5	plastic	fibre glass	balsa	5
1043	0,5-0,75-1-1,5-2-2,5-3	plastic	fibre glass	balsa	5
1044	0,3-0,5-0,75-1-1,25-1,5-2-2,5-3	fibre glass	fibre glass	balsa	5
1045	0,5-0,75-1-1,25-1,5-2-2,5-3	hollow	carbon	balsa	5
1046	0,4-0,6-0,8-1-1,25-1,5-2	hollow	carbon	balsa	5
1047	0,2-0,4-0,6-0,8-1-1,25-1,5-2	fibre glass	carbon	balsa	5
1048	0,4-0,6-0,8-1-1,25-1,5-2	fibre glass	carbon	balsa	5

Float with balsa antenna



Code	Weight gr	Antenna	Stem	Body mat.	Pcs/bag
1060	1-2-3-4-5-6-8	balsa	fibre glass	balsa	5
1061	0,2-0,4-0,6-0,8-1-1,5-2-2,5-3	balsa	fibre glass	balsa	5
1062	0,6-1-1,25-1,5-2-2,5	balsa	steel	balsa	5
1063	0,5-0,75-1-1,5-2-3-4-5	balsa	fibre glass	balsa	5
1064	1-1,5-2-2,5-3	balsa	fixed in one point	balsa	5
1065	0,6-1-1,25-1,5	balsa	fixed in one point	balsa	5

Balsa float with changeable star light antenna

BALSA



Code	Weight gr	Antenna	Stem	Body mat.	Pcs/bag
1201	1-1,5-2-2,5-3-4-5-6-8-10	plastic	fibre glass	balsa	5
1202	1-1,5-2-2,5-3-4-5-6-8-10	plastic	fibre glass	balsa	5
1203	1-1,5-2-2,5-3-4-5	plastic	fibre glass	balsa	5
1204	1-1,5-2-2,5-3-4-5	plastic	fibre glass	balsa	5
1205	2-3-4-5-6-8-10	plastic	fibre glass	balsa	5
1206	1-1,5-2-2,5-3-4-5-6-8-10	plastic	fibre glass	balsa	5
1207	1-2-3-4-5-6	plastic	fibre glass	balsa	5
1208	2-2,5-3-4-5-6-8	plastic	fibre glass	balsa	5

Diving floats

NEW



1310
1 pc/bag

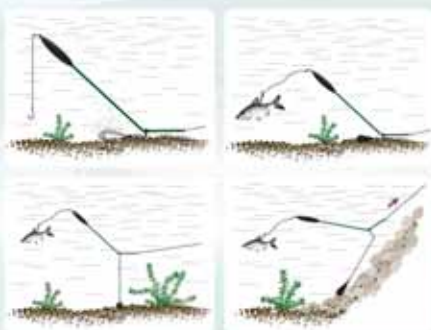

Starlight holding predator floats

BALSA



1301
Sizes:
15-25-30-40 gr

1302
Sizes:
10-15-20-25-30-40 gr

Packing of above mentioned (1201-1208 és 1301-1302) model: 5 pcs/bag

Mixed floats in one bag

Balsa floats - practical mixed packages

1045-mix

Martin Tear drop float
carbon stem Mix (Balsa)
Sizes: 0,75-1-1,25-1,5-2 gr



1038-mix

Livia Tear drop float with
fibr glass stem Mix (Balsa)
Sizes: 0,5-1-1,5-2-3 gr

1043-mix

Milan Tear drop float
with fibr glass stem Mix
(Balsa)
Sizes: 0,5-0,75-1-1,5-2 gr

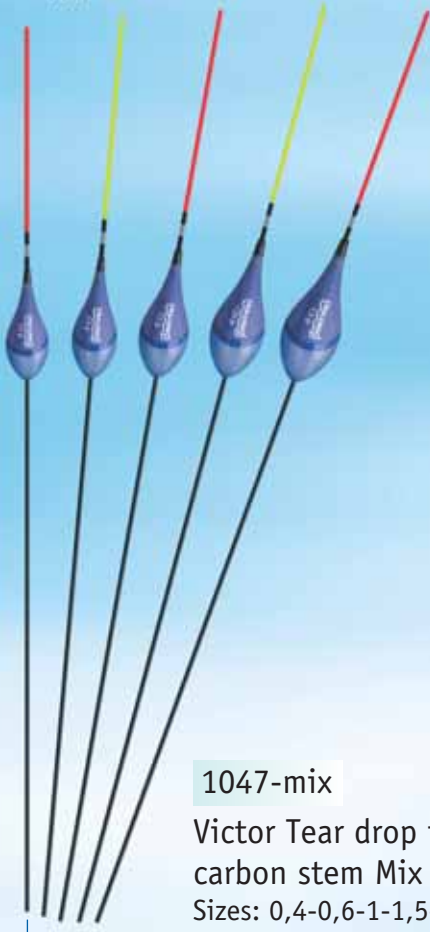

1047-mix

Victor Tear drop float
carbon stem Mix (Balsa)
Sizes: 0,4-0,6-1-1,5-2 gr

1061-mix

Genetic Tear drop
float fibr glass stem Mix
(Balsa)
Sizes: 0,6-0,8-1-1,25-1,5 gr



1207-mix

Starlight holding
Balsa float Mix (Balsa)
Sizes: 1-2-3-4-5 gr



Attachments

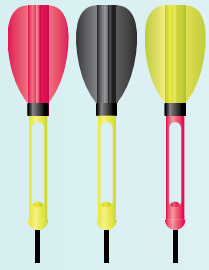

Dart antenna set (3 Pcs/bag)

2002

High visibility hollow antenna that aids float flight. 0,6 gr sensitivity

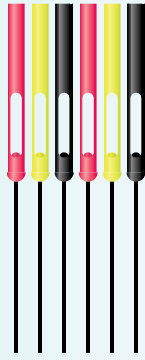

Hollow antenna set (6 Pcs/bag)

2003

Sensitive, highly visible hollow antenna with 0,3 gr sensitivity

Mixed antenna set (10 Pcs/bag)

2001

It can be used for both Cralusso Wagglers and polyurethane tear drop floats.

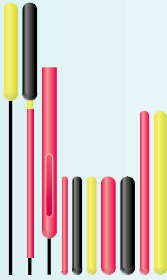

2011

Universal star light holder 4,5 mm-es (3 pcs/bag)



Wagglers float stem range (3 Pcs/bag)

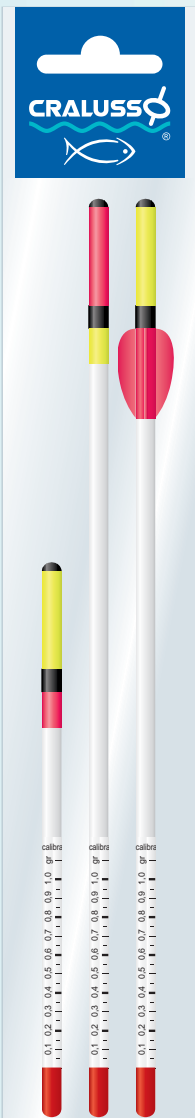

2004

DIY floats (8 Pcs/bag)



2010

Wagglers attachment Light (Fixed)

A sure and safe float fixing that allows quick changes. Tangles and knots are reduced because of the built in big load bearing swivel. The attachment is very light as carbon is used in the manufacture. We offer the small Wagglers attachment for 8-10 gr floats, and the medium attachment for floats above 10 gr.

Size	Code	Weight	Pcs/bag
Small	2005	0,22 gr	3 pcs
Medium	2005	0,35 gr	3 pcs



Anti tangle waggler attachment (Fixed)

Cralusso's own development! The success of the anti-tangle waggler attachment lies in the asymmetric design which allows the device to keep the line away from the float and so greatly reduce the possibility of tangles and knots.

Size	Code	Weight	Pcs/bag
Small	2006	0,30 gr	3 pcs
Medium	2006	0,45 gr	3 pcs

How to use this attachment?

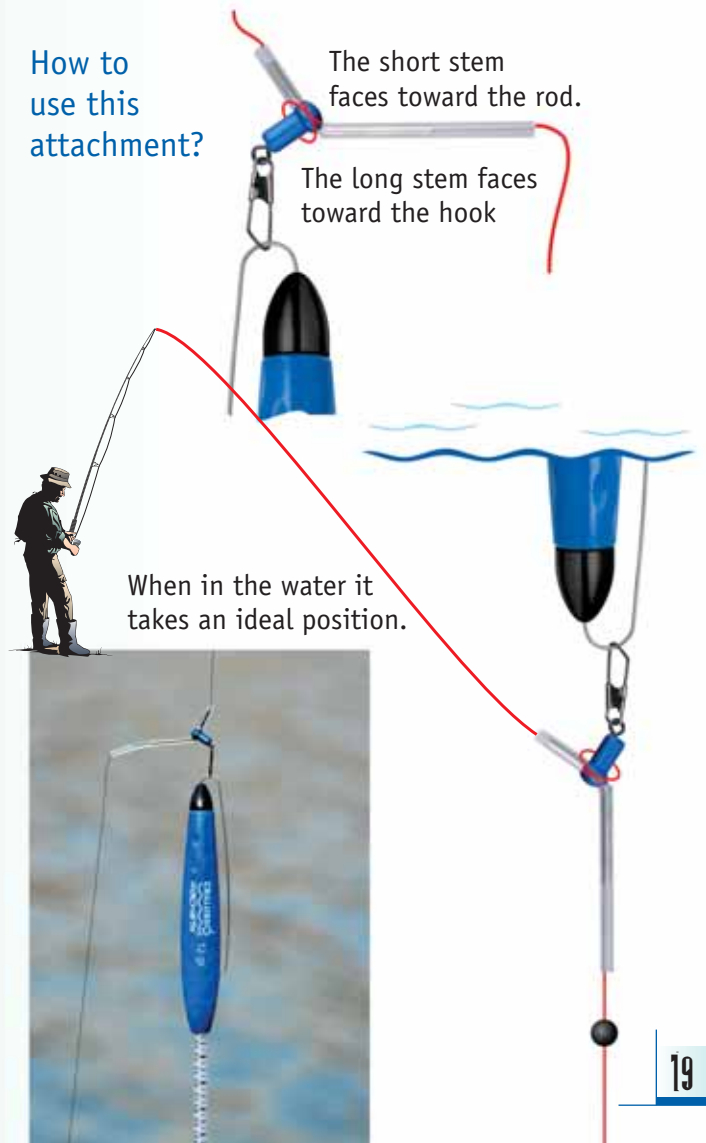



Olive rubber stopper
2008

Size	Pcs/bag
S	9 db
M	9 db
L	9 db



Adjustable float-holding roll

2032 S

2032 M



Float adaptors
For tear drop floats
2007

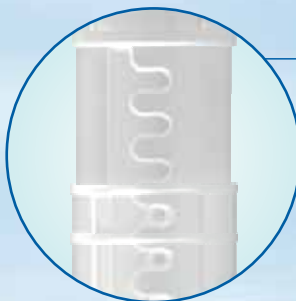
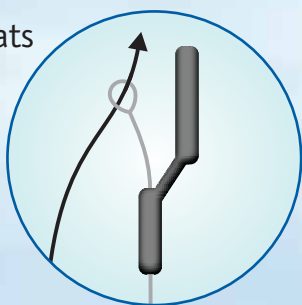

Adjustable roll-length

Size	Weight	Pcs/bag
Medium	0,1 gr	4 pcs

Line marker

2056

2055

2057



Fishing line winder **NEW**

2059





Silicon tubes 2009

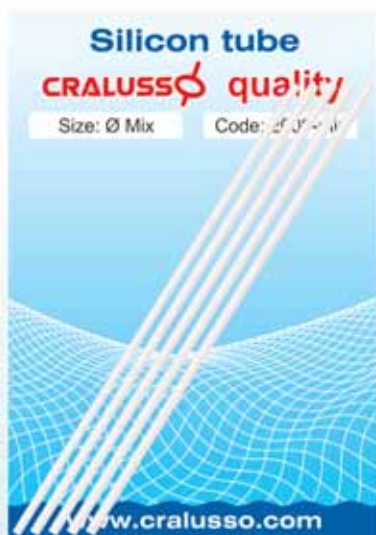

Silicon tubes mixed 2009-mix

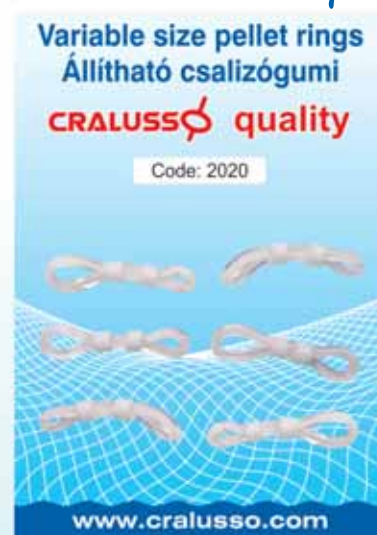

Variable size bait bands 2020



Pellet ring 2015
Sizes: S-M-L



Pellet ring mixed 2021-mix



Flare rubber thorn 2012-mix

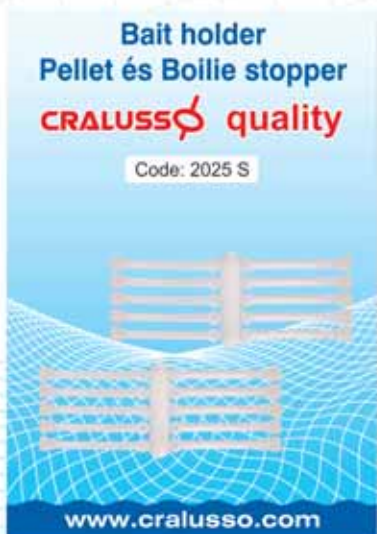

Bait holder 2025
Sizes: S-L



Float fixing set 2014-mix



Pellet stopper kit hard 2026

Cralusso lines = Cralusso quality!

“PRESTIGE” fishing line – as the name implies, this range will satisfy the highest demands of the modern angler. We believe different disciplines of fishing require a line specifically designed for the purpose and that each must possess the correct properties for its intended use. As such, we have developed and tested the lines over a period of some years and are certain we are now offering a selection of the very best available at a truly competitive price.

GENERAL Match

2060



A very reliable line with high tensile strength Excellent UV and abrasion resistance with silky smooth surface Specially recommended for general use and rig making

Length (m)	Diameter (mm)	Breaking Strain (kg)
150	0,12	2,24
150	0,14	2,75
150	0,16	3,46
150	0,18	4,14
150	0,20	5,12
150	0,22	6,54
150	0,25	8,19
150	0,30	11,22
150	0,35	15,49

Hooklength Line Soft & Strong

2061



Great attention to detail has been paid to ensure this line has the optimal relationship between strength and suppleness. It is reliable, strong and resistant to twist and tangles.

Length (m)	Diameter (mm)	Breaking Strain (kg)
50	0,088	1,18
50	0,102	1,57
50	0,123	2,34
50	0,143	3,07
50	0,160	3,84
50	0,178	4,61
50	0,201	5,71

Match Sinking

2062



This new generation sinking line has been developed specifically for waggler fishing. It possesses qualities of high abrasion resistance and extremely low surface friction which enables easy casting and creates fast sink rates

Length (m)	Diameter (mm)	Breaking Strain (kg)
150	0,14	2,21
150	0,16	2,77
150	0,18	3,31
150	0,20	4,10
150	0,23	5,23

FEEDER Energy

2063



This line is recommended for feeder fishing. It is very resilient and has a medium sink rate. The super low friction surface ensures fast movement through the water and positive contact with the fish

Length (m)	Diameter (mm)	Breaking Strain (kg)
150	0,18	4,4
150	0,20	5,5
150	0,22	6,9
150	0,25	8,6
150	0,30	11,8

CARP Power

2064



A line designed to suit the high demands of Carp anglers. It has qualities of high abrasion resistance and very low surface friction that assists with long range casting and minimises damage. It also ensures fast movement through the water and positive contact with the fish

Length (m)	Diameter (mm)	Breaking Strain (kg)
350	0,25	6,56
350	0,30	7,70
350	0,36	12,38



Cralusso lines = Cralusso quality!

FLUO LINE

2065

2066



150 m 350 m

A reliable fishing line with high tensile strength. UV and abrasion resistant. The extraordinary smooth surface ensures effortless long range casting.

Length (m)	Diameter (mm)	Breaking Strain (kg)
150	0,18	4,4
150	0,20	5,5
150	0,22	6,9
150	0,25	8,6
150	0,30	11,8

Length (m)	Diameter (mm)	Breaking Strain (kg)
350	0,18	4,4
350	0,20	5,5
350	0,22	6,9
350	0,25	8,6
350	0,30	11,8

BRAID LINE

2067



Universal braid with high levels of tensile strength and an abrasion resistant surface. The Dyneema material resists water absorption and provides an extra level of protection and durability.

Length (m)	Diameter (mm)	Breaking Strain (kg)
150	0,12	11,20
150	0,14	12,80
150	0,16	14,40
150	0,18	16,80
150	0,20	19,04
150	0,22	24,48
150	0,25	27,52

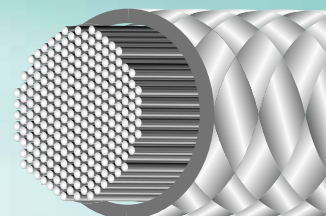

Infinity

NEW

2071



Length (m)	Diameter (mm)	Breaking Strain (kg)
500	0,20	5,1
500	0,22	6,5
500	0,25	8,2
500	0,30	11,2

LONG & STRONG CASTING

NEW

2075

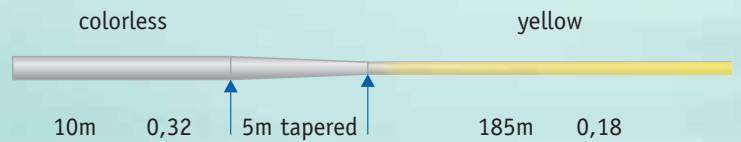

Length (m)	Diameter (mm)	Breaking Strain (kg)
200	0,32-0,18	10,9-3,5
200	0,35-0,20	13,4-4,4
200	0,40-0,22	16,0-5,7

~~X~~TREME

braid hooklength line

NEW

2080



Length (m)	Diameter (mm)	Breaking Strain (kg)
50	0,08	3,8
50	0,10	5,1
50	0,12	6,3
50	0,14	7,6
50	0,16	9,5



Hooks

Sode Light

2401



Flatted - Forged - Round

Size	Weight (gr)	Pcs/bag
18	0,004	14 db
16	0,005	14 db
14	0,008	16 db
12	0,012	16 db
10	0,017	16 db
8	0,029	16 db



18	16	14	12	10	8
----	----	----	----	----	---

Chika

2405



Flatted - Round

Size	Weight (gr)	Pcs/bag
18	0,005	16 db
16	0,008	16 db
14	0,014	16 db
12	0,018	14 db
10	0,024	14 db
8	0,029	14 db



18	16	14	12	10	8
----	----	----	----	----	---

Koaji Round

2410



Flatted - Round

Size	Weight (gr)	Pcs/bag
16-	0,009	16 db
14-	0,016	16 db
12-	0,023	14 db
10-	0,036	14 db
8-	0,049	14 db



16	14	12	10	8
----	----	----	----	---

Shin Aji

2415



Flatted - Large Forged

Size	Weight (gr)	Pcs/bag
11-	0,045	11 db
9-	0,066	10 db
7-	0,094	9 db
5-	0,14	8 db



11	9	7	5
----	---	---	---

Hooks

Umi Tango

2420

NEW



Flatted – Forged

Size	Weight (gr)	Pcs/bag
16-	0,014	12 db
14-	0,024	12 db
12-	0,034	12 db
10-	0,051	12 db
8-	0,083	11 db
6-	0,103	10 db



16

14

12

10

8

6

SB Chinu

2430

NEW



Double (one normal and one micro) edge point
– Flatted – Forged and Curved

Size	Weight (gr)	Pcs/bag
10-	0,049	10 db
8-	0,061	10 db
6-	0,077	9 db
4-	0,134	9 db
2-	0,2	7 db



10

8

6

4

2



Delta Chinu

2435

NEW



Triple edge point – Trust Grip – Forged and Curved

Size	Weight (gr)	Pcs/bag
10-	0,048	8 db
8-	0,07	8 db
6-	0,084	8 db
4-	0,137	7 db
2-	0,198	6 db



10

8

6

4

2



Accurate and fine laser carving on the end to prevent from the line come-off, trust cutting to restrain the line-moving.

This hooks is developed by latest technology, cutting the needle point by three different degree with uniqueedge form.



Quality swivels and accessories at a reasonable price!

Golden swivel

2110

Exclusive Design



Size	Test	Weight	Pcs/bag
3	40 kg	0,41 gr	10 db
5	32 kg	0,25 gr	12 db
7	22 kg	0,13 gr	12 db
10	14 kg	0,07 gr	12 db
14	4 kg	0,04 gr	12 db

Rhombus swivel

2111



Size	Test	Weight	Pcs/bag
5	27 kg	0,25 gr	12 db
7	19 kg	0,13 gr	12 db
10	9 kg	0,07 gr	12 db
14	4 kg	0,04 gr	12 db

Double swivel

2112



Size	Test	Weight	Pcs/bag
5	32 kg	0,44 gr	12 db
7	22 kg	0,25 gr	12 db
10	14 kg	0,13 gr	12 db
14	4 kg	0,06 gr	12 db

Triple speed swivel

2113



Size	Test	Weight	Pcs/bag
7	22 kg	0,23 gr	12 db
10	14 kg	0,112 gr	12 db
14	4 kg	0,062 gr	12 db

Triple chain swivel

2114



Size	Test	Weight	Pcs/bag
7	22 kg	0,23 gr	12 db
10	14 kg	0,112 gr	12 db
14	4 kg	0,062 gr	12 db

Swivel & safety snap

2115



Size	Test	Weight	Pcs/bag
5	9 kg	0,40 gr	12 db
7	7 kg	0,23 gr	12 db
10	5 kg	0,14 gr	12 db
14	3 kg	0,10 gr	12 db

Crane swivel with interlock snap

2116



Size	Test	Weight	Pcs/bag
2	18 kg	0,52 gr	10 db
4	14 kg	0,38 gr	12 db
6	12 kg	0,26 gr	12 db
8	10 kg	0,16 gr	12 db
10	9 kg	0,12 gr	12 db

Swivel with hooked snap

2117



Size	Test	Weight	Pcs/bag
4	70 kg	2,05 gr	12 db
7	20 kg	0,25 gr	12 db
10	12 kg	0,13 gr	12 db
14	4 kg	0,06 gr	12 db

Quality swivels and accessories at a reasonable price!

Ball bearing swivel with snap

2118



Size	Test	Weight	Pcs/bag
0	12 kg	0,32 gr	6 db
1	18 kg	0,52 gr	6 db
2	25 kg	0,76 gr	6 db
4	35 kg	1,60 gr	6 db

Swing coastlock snap

2119



Size	Test	Weight	Pcs/bag
6	30 kg	0,32 gr	12 db
8	19 kg	0,20 gr	12 db
10	14 kg	0,12 gr	12 db
12	9 kg	0,08 gr	12 db

Side-line rolling swivel

2120



Size	Test	Weight	Pcs/bag
2	43 kg	0,88 gr	6 db
4	35 kg	0,56 gr	6 db
6	30 kg	0,32 gr	6 db
8	19 kg	0,18 gr	6 db

Corner plate swivel

2121

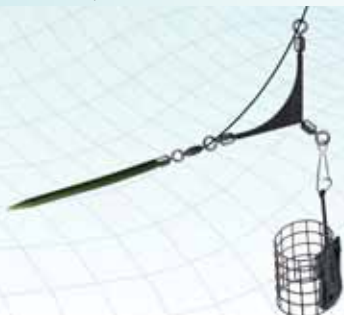

Size	Weight	Pcs/bag
6	1,3 gr	3 db
8	0,94 gr	3 db
10	0,57 gr	3 db

Brass Head Safety Snap

2122



Size	Weight	Pcs/bag
S	0,17 gr	6 db
M	0,26 gr	6 db

Plastic head swivel with interlock snap

2123



Size	Weight	Pcs/bag
S	0,15 gr	6 db
M	0,23 gr	6 db

Hooked snap

2125



Size	Test	Weight	Pcs/bag
00	9 kg	0,03 gr	12 db
0	12 kg	0,04 gr	12 db
1	20 kg	0,08 gr	12 db
2	28 kg	0,13 gr	12 db
3	35 kg	0,20 gr	12 db



Quality swivels and accessories at a reasonable price!

Mixed swivel

2126-mix

Practical packing of three basic types with 4 sizes



Rolling swivel with nice snap

2127



Size	Test	Weight	Pcs/bag
4/0	70 kg	2,05 gr	4 pcs
2/0	44 kg	1,45 gr	6 pcs
1	38 kg	0,92 gr	10 pcs
3	33 kg	0,68 gr	12 pcs
5	27 kg	0,44 gr	12 pcs
7	20 kg	0,27 gr	12 pcs
10	12 kg	0,13 gr	12 pcs

Quick snap with fixing tube

2128

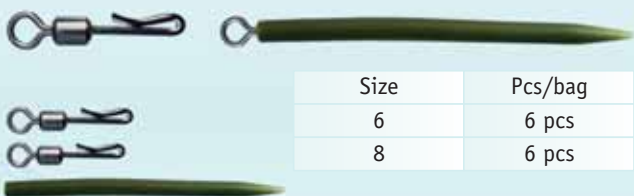

Size	Pcs/bag
6	6 pcs
8	6 pcs

Safety lead snap kit

2130

2x6 pcs/bag



Swivel with pearl beads and rubber stopper

2129



Size	Pcs/bag
M	2x4 pcs

Slipping feeder fixing set

2131

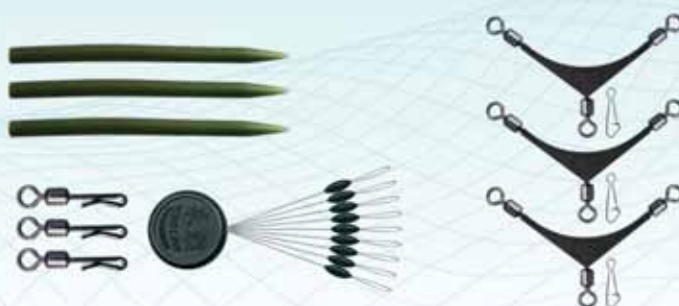

Match Quick snap

2132



Size	Pcs/bag
12	6 pcs
14	6 pcs

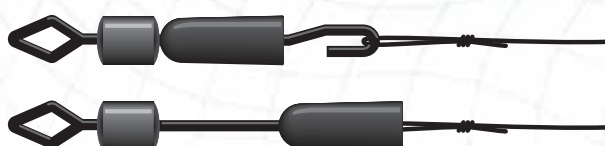

Swivel with side line clip

2135



Size	Test	Weight	Pcs/bag
6	22 kg	0,32 gr	12 pcs
8	14 kg	0,20 gr	12 pcs
10	9 kg	0,12 gr	12 pcs
12	4 kg	0,08 gr	12 pcs

Soft beads

NEW

2140 1x2mm 8 pcs

2141 1,2x6mm 8 pcs



Maggot clips

2145

NEW

11x14x0,5 mm

6 pcs/bag



Distance holders, Fixing wedges

Fixing Wedge

2201 **NEW**



(M) (L)



1 pcs/bag

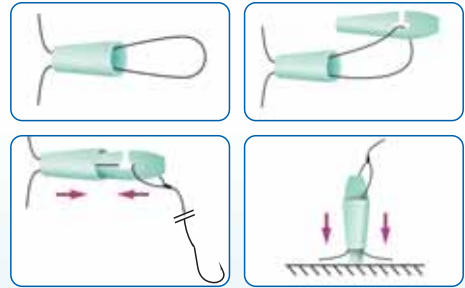

Distance Holder T-stop

2202 **NEW**



4 pcs/bag

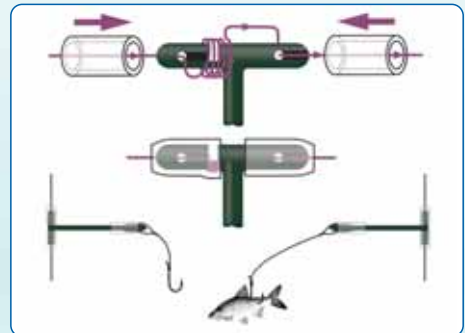

Full stop arrester

2203 **NEW**



1 pcs/bag



Rotaiting T Distance holder

2204 **NEW**

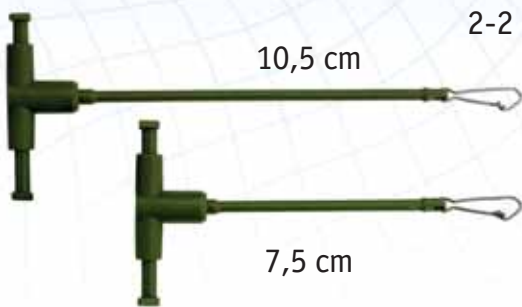

2-2 pcs/bag

(L)

(M)

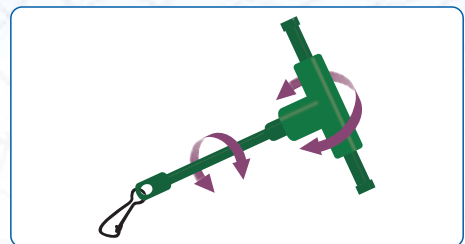

T Distance holder

2205 **NEW**

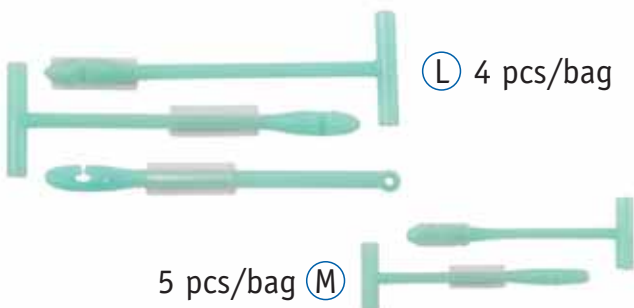

(L) 4 pcs/bag

5 pcs/bag (M)

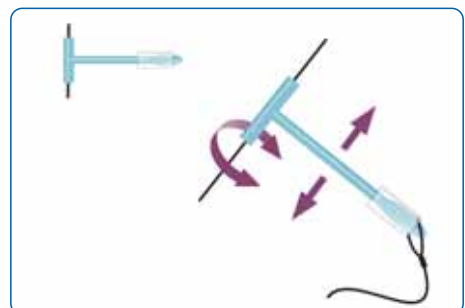



Feeder Basket

Flat Feeder Basket

3005



Code	Weight	Pcs/bag
3005-20	20 gr	10 pcs
3005-30	30 gr	10 pcs
3005-50	50 gr	10 pcs
3005-70	70 gr	10 pcs
3005-100	100 gr	10 pcs

Flat/spring feeder basket with anti tangle tube

3006



Code	Weight	Pcs/bag
3006-14	14 gr	10 pcs
3006-20	20 gr	10 pcs
3006-30	30 gr	10 pcs
3006-50	50 gr	10 pcs
3006-70	70 gr	10 pcs
3006-100	100 gr	10 pcs

Square feeder basket with 8 lines square

3010

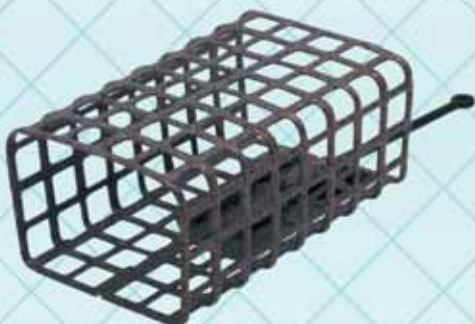

Code	Weight	Pcs/bag
3010-10	10 gr	10 pcs
3010-15	15 gr	10 pcs
3010-20	20 gr	10 pcs
3010-25	25 gr	10 pcs
3010-30	30 gr	10 pcs
3010-40	40 gr	10 pcs
3010-50	50 gr	10 pcs
3010-60	60 gr	10 pcs
3010-70	70 gr	10 pcs

Wire feeder basket with 5 lines round

3011



Code	Weight	Pcs/bag
3011-5	5 gr	10 pcs
3011-10	10 gr	10 pcs
3011-15	15 gr	10 pcs
3011-20	20 gr	10 pcs
3011-25	25 gr	10 pcs
3011-30	30 gr	10 pcs

Wire feeder basket with 5 lines square

3012



Code	Weight	Pcs/bag
3012-5	5 gr	10 pcs
3012-10	10 gr	10 pcs
3012-15	15 gr	10 pcs
3012-20	20 gr	10 pcs
3012-25	25 gr	10 pcs
3012-30	30 gr	10 pcs

Feeder Basket

Pellet feeder basket

3018



NEW

Code	Weight	Pcs/bag
3018-25	25 gr	2 pcs
3018-35	55 gr	2 pcs
3018-45	45 gr	2 pcs

Rocket feeder basket

3019



NEW

Code	Weight	Pcs/bag
3019-15	15 gr	2 pcs
3019-25	25 gr	2 pcs
3019-35	35 gr	2 pcs
3019-50	50 gr	2 pcs
3019-70	70 gr	2 pcs

Ribbed feeding basket with anti tangle tube

3014



Code	Weight	Pcs/bag
3014-10	10 gr	10 pcs
3014-15	15 gr	10 pcs
3014-20	20 gr	10 pcs
3014-25	25 gr	10 pcs
3014-30	30 gr	10 pcs
3014-35	35 gr	10 pcs
3014-45	45 gr	10 pcs
3014-60	60 gr	10 pcs

Inline ribbed feeder basket

3015



Code	Weight	Pcs/bag
3015-25	25 gr	10 pcs
3015-35	35 gr	10 pcs
3015-45	45 gr	10 pcs
3015-60	60 gr	10 pcs
3015-80	80 gr	10 pcs
3015-100	100 gr	10 pcs

Anti tangle tube with strong end

3101



Code	Size	Pcs/bag
3101-30	30 mm	3 pcs
3101-55	55 mm	3 pcs
3101-85	85 mm	3 pcs
3101-120	120 mm	3 pcs

Anti tangle tube with hooked snap

3102



Code	Size	Pcs/bag
3102-80	80 mm	3 pcs
3102-120	120 mm	3 pcs
3102-180	180 mm	3 pcs

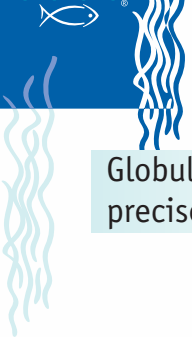

Globular weight with central hole, precise cut and protector tube



The quality manufacture and tube makes it possible to fix perfectly centrally and without causing damage

Olive weights with silicone,- two functions in one lead

If the line is threaded through the tube, the olivette can be used as a sliding weight.

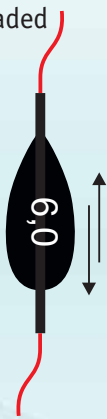

If fixed to the line by silicon tubes, then it can be used as changeable weight.



3001



3001-mix



Code	Weight	Pcs/bag
3001-1	1,0 gr	5 pcs
3001-1,5	1,5 gr	5 pcs
3001-2	2,0 gr	5 pcs
3001-2,5	2,5 gr	5 pcs
3001-3	3,0 gr	5 pcs
3001-4	4,0 gr	5 pcs
3001-5	5,0 gr	5 pcs
3001-6	6,0 gr	5 pcs
3001-7	7,0 gr	5 pcs
3001-8	8,0 gr	5 pcs
3001-10	10,0 gr	4 pcs
3001-12	12,0 gr	4 pcs
3001-15	15,0 gr	4 pcs
3001-18	18,0 gr	3 pcs
3001-20	20,0 gr	3 pcs
3001-25	25,0 gr	2 pcs
3001-30	30,0 gr	2 pcs
3001-mix	Mixed	5 pcs

Environment friendly
Weights without lead

3041 / 3042-mix



3051 / 3052-mix



3061 / 3062-mix



Code	Weight	Pcs/bag
3002-1	1,0 gr	5 pcs
3002-1,5	1,5 gr	5 pcs
3002-2	2,0 gr	5 pcs
3002-2,5	2,5 gr	5 pcs
3002-3	3,0 gr	5 pcs
3002-4	4,0 gr	5 pcs
3002-5	5,0 gr	5 pcs
3002-6	6,0 gr	5 pcs
3002-7	7,0 gr	5 pcs
3002-8	8,0 gr	5 pcs
3002-mix	Mixed	5 pcs

Weight	Pcs/bag
0,5 gr	10 pcs
1,0 gr	7 pcs
1,5 gr	6 pcs
2,0 gr	5 pcs
3,0 gr	4 pcs
4,0 gr	3 pcs
5,0 gr	2 pcs
6,0 gr	2 pcs
0,5-1-2-3-4 gr	5 pcs

Torpillo

3021



Olive weight with plastic tube

3004

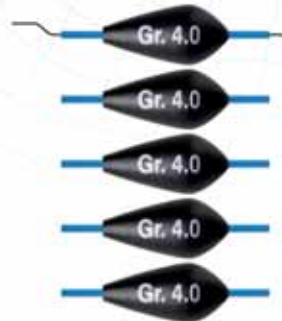

Code	Weight	Pcs/bag
3004-1	1,0 gr	6 pcs
3004-1,25	1,25 gr	6 pcs
3004-1,5	1,5 gr	6 pcs
3004-2	2,0 gr	5 pcs
3004-2,5	2,5 gr	5 pcs
3004-3	3,0 gr	5 pcs
3004-4	4,0 gr	5 pcs
3004-5	5,0 gr	4 pcs
3004-6	6,0 gr	4 pcs
3004-7	7,0 gr	4 pcs
3004-8	8,0 gr	3 pcs
3004-10	10,0 gr	3 pcs

Sounding weight

3003



Code	Weight	Pcs/bag
3003-5	5,0 gr	5 pcs
3003-10	10,0 gr	4 pcs
3003-15	15,0 gr	4 pcs
3003-20	20,0 gr	3 pcs
3003-35	35,0 gr	2 pcs

T-shirt

Royal blue and white, Cralusso logo is in front and back, hard-wearing and fine material.



Code: 4001

Code: 4002

Cralusso caps:
Softish material,
adjustable size,
hard wearing,
embroidered in front.

Code: 4003



Code: 4005

Code: 4004

Code: 4006

Fleece sweater embroidered on both sides

Code: 4020

Size:

M - L - XL - XXL





Innovative Fishing Floats

Králík & Tsa. Kkt.
H-2600 Vác Naszály u.2.
Phone/fax:+36/27-304-327
e-mail:cralusso@cralusso.com

www.cralusso.com