

2023



Innovative Fishing Products

CRALUSSO,  
CHOICE OF THE WINNERS



[www.cralusso.com](http://www.cralusso.com)



From the 900.000 enterprises based in Hungary Mr. Karoly Kralik was chosen, due to his domestic and international results, the creator of Cralusso float range was asked to become a Hungarian Talent Ambassador.

When I decided to launch Cralusso I knew that instead of improving on existing products I would have to set off in an entirely new direction, developing new solutions and technologies. Our revolutionary innovations, such as our ground-breaking fishing floats enabled users to win countless world, European and national championships. During the recent years and months we have been focusing on reforming feeder and method equipment. Our unrivalled models were developed with the help of cutting-edge 3D printing technology. I am sure we have made our mark – these products can help make fishing even more enjoyable and successful.

### Cralusso, choice of the winners



In 2015 has reached another World Cup victory with our products. The Club's Team World Championship, which held in Zilina, the Slovakian Team take possession of first place with Cralusso floats

### Main milestones:

- 2002: Launch Cralusso
- 2003: World Championship – Torpedo
- 2005: European Championship – Torpedo
- 2006: Innovation Expo, GENIUS award
- 2007: U.S. Open – Golf and Bubble
- 2008: European Championship – Torpedo
- 2008: U.S. Open – Shark
- 2008: Hungarian National Championship – Shark
- 2009: Best Stand award
- 2010: Sponsorship at Poznan World Cup
- 2012: Title of Hungarian Talent Ambassador
- 2013: Expand the NAVIGATOR line
- 2014: Dutch men's team – the title of world champion  
Hungarian team of disabled people – individual and team title of world champion  
Hungarian team of veterans – world champion bronze medal

- 2015: Best Stand award  
Slovakian Team won the Club Team World Championship with Torpedo floats
- 2018: Our company has won a research and development tender. We have established our development workshop equipped with state-of-the-art machines to provide a foundation for the innovations in the coming years.
- 2019: The Bosnian team that won club world championship using our Raj and Torpedo floats in Prelog, Croatia.
- 2022: Our innovative developments has earned EFTTEX awards.



**Novelties**

Jelly Snail  
 39. page

**NOT PLASTIC**  
 Full natural!



Zero Weightless Feeder basket  
 45. page



Big Rocket Method  
 basket • 51. page

**1**  
 Year  
 Guarantee



Big Rocket Method Sets  
 52. page

**1**  
 Year  
 Guarantee



A new hydrodynamic form developed by Cralusso, the body does not lift out the water when held back. This float is for use on the pole and is ideal for use in medium or strong flow when you wish to present static or slow moving baits. It is so good and reliable that it has become the number one choice of flat float for anglers of all abilities including a few world champions!

Some quotations about the Torpedo:

- **Alan Scotthorne:** "The best flat float I've ever used"  
*Angling Times, May 10 2005.*
- **Bob Nudd:** "It will add a new dimension to your polefishing"

*Angling Times 31 May 2005*

Sizes:

0.5 - 0.75 - 1.0 - 1.5 - 2.0 - 3.0 - 4.0 - 5.0 gr

PUR



Code: 1001

**TORPEDO Tuning**

An advanced version of the Torpedo float, which helped the Hungarian team to win gold in the 2003 World Championship. The Torpedo Tuning was also the success story of the 2005 European Championship - 80% of the contestants used our floats, including Will Raison, the individual champion.



PUR

As with the Torpedo, this float is for use on the pole and is ideal for use in medium or strong flow when you wish to present static or slow moving baits.

Sizes: 6 - 8 - 10 - 12 - 15 - 20 - 25 - 30 - 40 - 50 - 70 gr

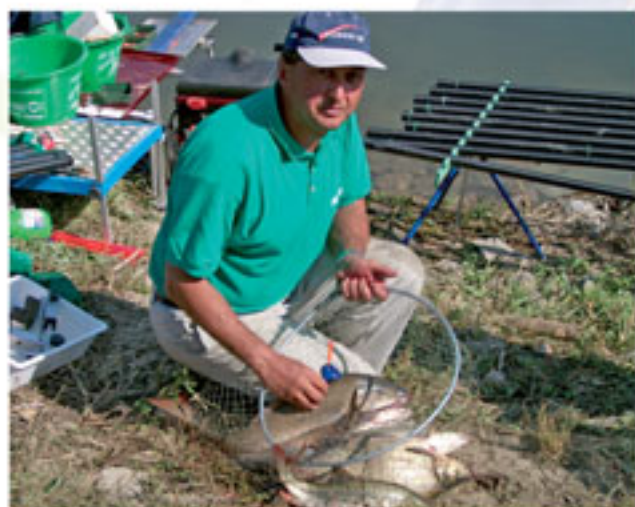

With recommendation of Tibor Ambrus, world champion

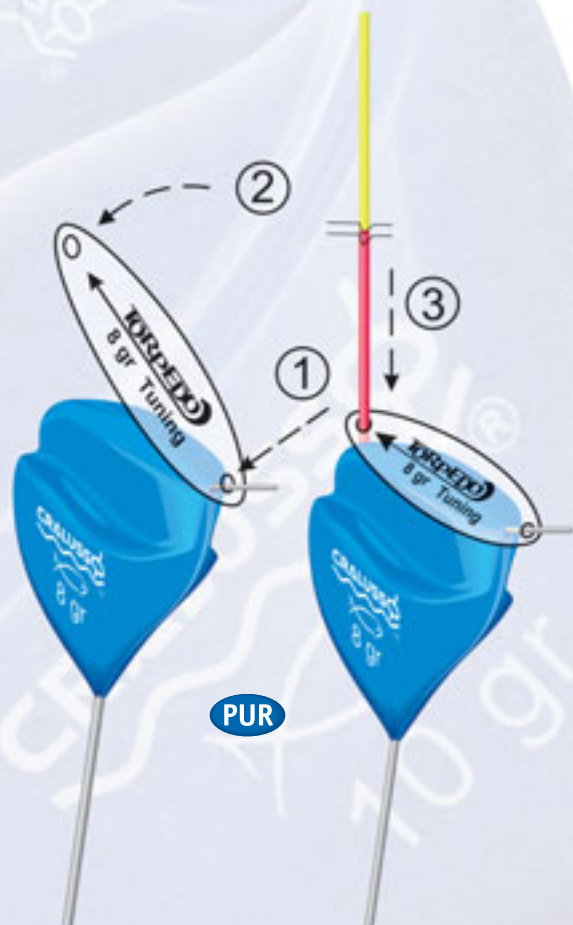

PUR

3  
Year  
Guarantee



# Bubble



Code: 1003

A river float designed for use on the pole but has found favour with many anglers on the running line. It is ideal for running through the swim at variable speed. The Bubble was introduced in 2005 Madunice European Championship.

**The winner of U.S. Open in 2007 and 2008!**

Variable antenna 1-5 gr 2 pcs  
Variable antenna 6-20 gr 5 pcs  
Waterproof polyurethane body  
Floats can be changed without dismantling the rig

Sizes:

1 - 1,5 - 2 - 3 - 4 - 5 - 6 - 8 - 10 - 12 - 15 - 20 gr  
30 - 40 - 50 gr



The next step of success!  
József Papp won the 2008 U.S. open using  
a Cralusso Bubble

# SHARK

Functions of two floats in one 2 in 1 Code: 1004

1  
Year  
Guarantee

- 1 You should use the first antenna position when you are holding the float back hard or even lightly.
- 2 You should use the second antenna position when you want the float running through the swim

Sizes:

1 - 1,5 - 2 - 3 - 4 - 5 - 6  
8 - 10 - 12 - 15 - 20 gr  
25 - 30 - 40 - 50 gr

Shark, the brand new flat float was developed using many years of experience in float design and was in response to the demand from professional anglers. Used primarily for pole fishing the float can present baits in many ways. The antenna position can be changed according to your technique – whether this is holding back hard or running the float through the swim.

When the current is strong or you are holding back hard use the first bristle position. When the flow is slower or you want to run the float through the swim the second bristle position is recommended.

The streamline hump on top of the float – the sharks fin – aids stability and sensitivity – even the smallest of bites can be seen clearly.

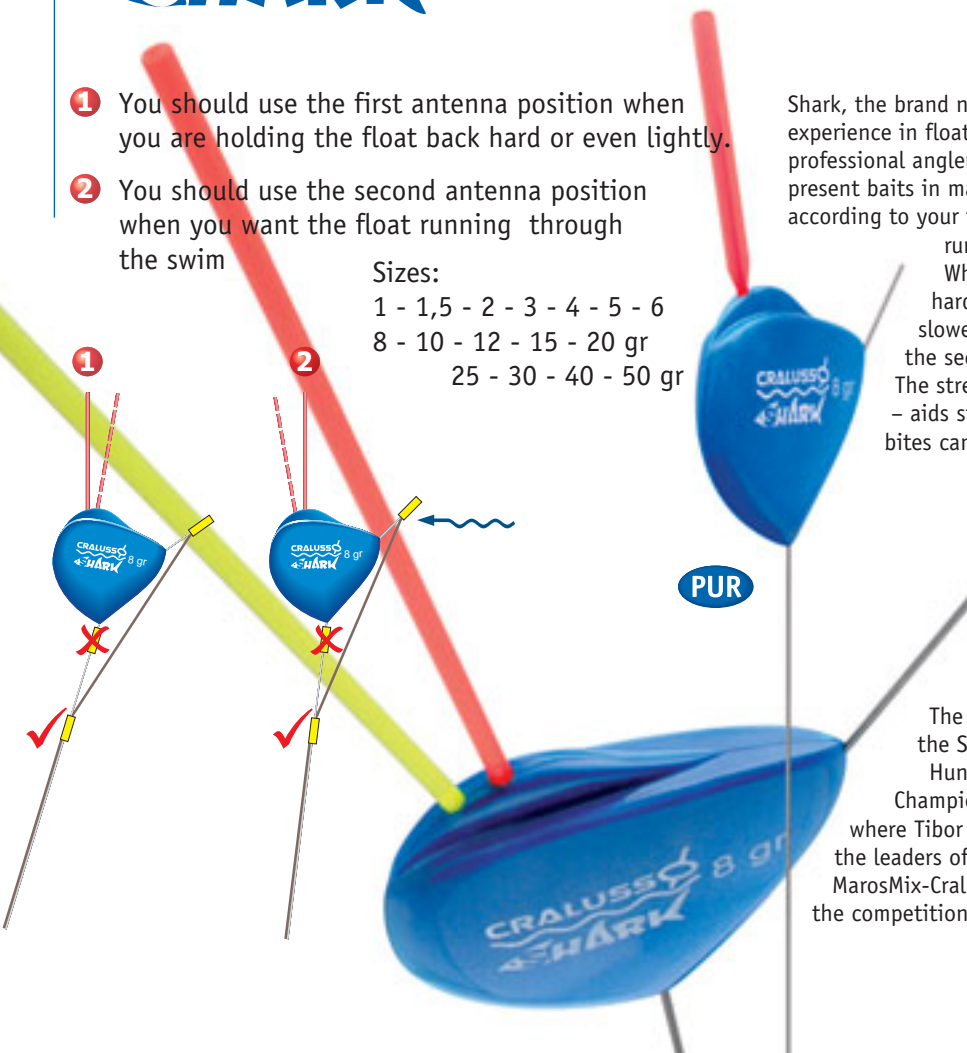

The introduction of the Shark was at the Hungarian National Championship in 2008, where Tibor Ambrus, one of the leaders of the Tubertini-MarosMix-Cralusso group won the competition using this new float.

## Choice of the Champions

Code: 1027

This hard-wearing polyurethane disc float developed by Cralusso can take the place of traditional balsa models, that can be damaged easily.



Sizes:  
1 - 1,5 - 2 - 3 - 4 - 5 - 6 - 8 - 10 - 12 - 15 - 20 gr  
25 - 30 - 40 - 50 gr

The favourite float of the world championship held in Croatia in 2014, helping the Dutch team to earn the title of world champion



In this competition, Alan Scotthorne – five times individual world champion of England – and many other teams have used the innovative Cralusso floats!

# Surf

Code: 1002

A special river float for use with rod and reel set ups that can be held back hard without drifting in across the flow. The direction and speed can be changed easily offering perfect and accurate presentation. Ideal for medium and strongly currents although it can be used on still water for predator fishing when you wish to work a baitfish parallel to the bank.



Sizes:  
3 - 4 - 6 - 8 - 10 - 12 - 15 - 20 gr

# Bolo

Code: 1005

Sizes:  
3 - 4 - 6 - 8 - 10 - 12  
15 - 20 gr

A river float for use Bolognese rods and any running line set up. The design allows you to hold the float back without it drifting in across the flow. You can vary the speed of travel easily, but in sufficient flow and by holding back hard it is possible to lead the Bolo out from the bank toward features, cover or your feed line. You can effectively position the float before letting it run through the swim.





Code: 1007

The Ufo and Dart floats utilize Cralusso's innovations, which give them their efficacy and popularity.

- 1
- 2
- 3
- 4

Adjusting the antenna and the sensitivity can be performed repeatedly using the calibration solution. They've become preferred by the anglers because of their versatile, simple usage and their durable design.

The concept is the same as that found in the UFO waggler but in addition to the other latest developments this version incorporates a flight.

- 1
- 2
- 3
- 4

The body is made of polyurethane, which is not sensitive to surface damage. The Dart is a very versatile float, which is a suitable for both pleasure and match anglers alike.

The aerodynamics are improved with surface indentations (as on a golf ball) which reduces air resistance and increases stability.



Recommended float adaptors  
 Waggler Attachment Light: 2005  
 Brass Head Safety Snap: 2122  
 Plastic head swivel with interlock snap: 2123

# DART

Code: 1008

1 Thanks to the versatile and adaptable antenna system, twenty Cralusso sight tips can be used with this float. Three tips are contained in each pack.

The removable dart wings help the floats to the flight.

2 The stem of the float is made from a material that is very strong and will remain straight without becoming twisted or curved.

3 The calibration system helps quick, simple and accurate adjustments, with 0,05 gr graduations being possible

PUR

4

Size gr	Changeable weight
6	2,5 gr
8	3,0 gr
10	3,0 gr
12	3,0 gr
14	3,5 gr
16	3,5 gr
18	4,5 gr
20	5,5 gr

# Sensitive

Code: 1010

# Pellet

Code: 1011

This near indestructible float has been made for the ever more popular method of pellet waggler fishing. Being short it can be used successfully when fishing shallow and presenting baits deeper is no problem. You can fish precisely with different sizes and weights of pellet by making adjustments to the capacity of the float using the calibration system.



Sizes: 5 - 7 - 9 - 11 gr

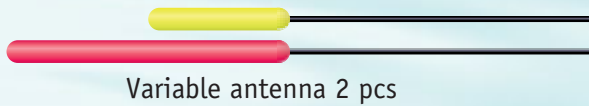

Variable antenna 2 pcs

Type	Distance of Casting	Changeable weight
<b>Pro Carbon</b> 8-16 gr	35-60 m	1,0-5,0 gr
<b>Rocket</b> 6-20 gr	40-85 m	2,0-3,5 gr
<b>Helio</b> 8-30 gr	40-75 m	2,5-15 gr
<b>Dart</b> 6-20 gr	35-65 m	2,5-5,5 gr
<b>Sensitive</b> 5-11 gr	35-55 m	1,5-3,0 gr
<b>Ufo</b> 6-20 gr	30-50 m	2,5-5,5 gr

Sizes:  
S - L



PUR





# proCarbon

## Waggler

Code: 1084

Professional waggler float, offering unique solutions for competitive and hobby angling as well. The float has a tapered carbon stem, a polyurethane body and tungsten discs.

A rotary part with a bearing is built into the lead head, which brakes, bends when it falls. The calibration solution developed by Cralusso allows for the quickest and most sensitive antenna setting to adjust with as little as 0.01 gramm. 1 year warranty!

Size gr	Changeable weight
8	1 gr
10	2 gr
12	3 gr
14	4 gr
16	5 gr

PUR

Strengthened pillow swivel built-in the lead head



The new combination of lead and tungsten weight discs has a high specific gravity and is therefore only half the volume of brass.

# WolframMatch

Code: 1085

We have been ecstatic over the success of the Arrow waggler but we never rest and have achieved even further improvement for this year. In addition to the already successful developments

1 2 3 4

we are now using a weight system that is twice as heavy as brass.

This lead/tungsten combination disc system together with the new aerodynamically refined body has created an even better flight, operation and precision in use.

The antenna system consists of over 20 versions with varying diameters, lengths and colours available. New to this range are the 'air antenna' - a clever highly visible tube and a very sensitive solid option.

Size gr	Changeable weight
8	2,5 gr
10	4,5 gr
12	6,5 gr
14	8,5 gr
16	10,5 gr
18	8,0 gr
20	10,0 gr

Tip: With the help of the unique calibration system you can speed up the float setting process and also achieve very precise setting of the antenna.

Strengthened pillow swivel built-in the lead head



New antenna with helium



Code: 1087

Professional waggler float with calibration system, new body shape, made using tungsten & helium!

Code: 1086

Our newest innovation, the HELIO waggler float incorporates the best of our knowledge. We used materials with the most optimal density, this means that the lead head, the tungsten discs and the helium-filled float body and shank provided the possibility to build an ideal float, which

- has the best flying capabilities;
- can be set to the highest sensitivity
- can be weighted in the shortest time
- has a stem that does not bend even on higher temperatures
- resists damage
- can hold over 30 types of antennas

Size gr	Changeable weight
8	2,5 gr
10	4,5 gr
12	6,5 gr
14	8,5 gr
16	10,5 gr
18	8,5 gr
20	10,5 gr
25	10,0 gr
30	15,0 gr

Lead - tungsten combined weight system



The new combination of lead and tungsten weight discs has a high specific gravity and is therefore only half the volume of brass.

Heeding the requests of the anglers, we added to our offer this easy to use, easy to throw Slider float, which satisfies the highest demands of the hobby and sport anglers. The 3.0 gr net weight of the special slider head and the design of the PUR body give excellent flying capabilities to the float. It is mainly recommended for deep water and lakes with strong currents, when the bait needs to be sunken to the vicinity of the lakebed quickly and in a stable way.

- Simple, precise usage
- Fastest antenna and sensitivity adjustment with the help of the calibration system.
- Versatile variability for weighting
- Replaceable solid and air-filled antennas

Sizes
3 + 8,0 gr
3 + 10,0 gr
3 + 12,0 gr
3 + 14,0 gr
3 + 16,0 gr
3 + 18,0 gr

**Tip:** The new waggler stem set (Item: 2034), increase the capacity and variability of the float. The different length of stems (250-330), can be accelerate the balance, furthermore increase the distance of flight.

Sizes: 8-10-12-14-16-18 gr

Attention! The calibration stem shouldn't be extended further than the red mark!

PUR

# The aim of continuous innovation to create the best waggler float!

## ARROW waggler

Code: 1040

Incorporates a removable brass disc weight system and, of course, all the usual Cralusso innovative features

- 1 2 3 4

The ARROW waggler ensures an aerodynamic flight, high levels of sensitivity and offers a multifunctional, easy to use float. The longer stem offers the following advantages:

- Generates extraordinary stability and distance in flight
- The body and main weight of the float sits deep in the water and it is therefore less influenced by wind and surface skim
- The long float aids the important task of getting your line deep in the water

Transportation of the long float is not difficult as the stem and body can be separated. This allows the carrying of made up rods where required with no risk of float damage.

Size gr	Changeable weight
8	3,0 gr
10	4,0 gr
12	5,0 gr
14	6,0 gr
16	7,0 gr
18	8,5 gr

PUR



## BREAM FLOAT

Code: 1082

Size gr	Changeable weight
6	1,5 gr
8	2,5 gr
10	3,0 gr
12	4,0 gr
14	5,0 gr
16	6,0 gr



By sliding the tube to calibrate the float you can minutely adjust the weighting.

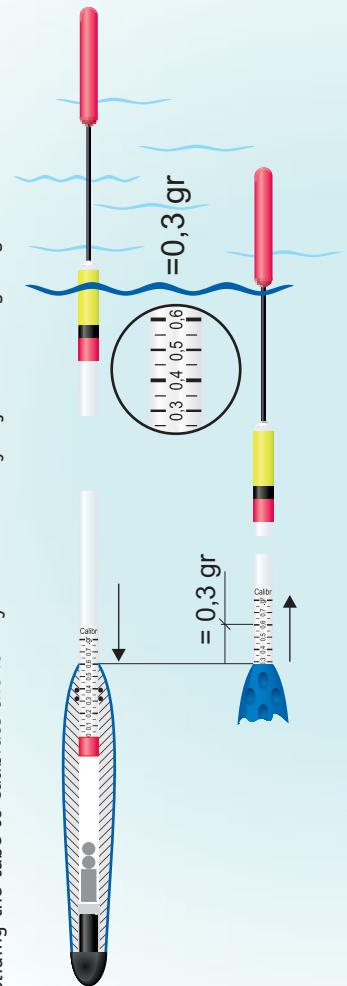

Strengthened pillow swivel built-in the lead head





## Multicolor waggler

Code: 1013

Size gr	Changeable weight
8	2 gr
10	2 gr
12	2 gr
14	2 gr



## Unweighted slider floats

Code: 1029

Sizes:  
3-4-5-6-8 gr



## CONTROL MATCH

Code: 1023

Cralusso's newest development is a perfect solution for the problems of many anglers. We have used the very popular calibration system from our bodied wagglers and have also managed to incorporate this system into our revolutionary new straight wagglers. The slim body creates a very sensitive float and the calibration system makes very fast and accurate adjustment possible.

## CONTROL MATCH

with dart

Code: 1024

The construction of this float is the same as the "Control Match", but we incorporated dart flights into the stem to allow even better flight. The antenna are inter-changeable.

Sizes:

You can adjust the 3-4-5 gr float's loading capacity between 0 and +1,2 gr.

You can adjust the 6-7-8-10 gr float's loading capacity between 0 and +1,5 gr



By sliding the tube to calibrate the float you can minutely adjust the weighting.

## PRO MATCH

Code: 1025

"Pro Match" floats contain all the useful developments that make the 'Control' version unique. As we have used brass removable heads, it is possible for finer adjustments to be made and for the carrying capacity to be increased still further. It is possible to make very quick, accurate and repeated adjustments by pushing in, or pulling out, the upper, thinner stem from the body of the float.

## PRO MATCH with dart

Code: 1026



The adjustable capacity of the 4 gr float is: between 0 and +2,5 gr  
 The 5 gr and 6 gr float is: between 0 and +3,0 gr  
 The 7 gr and 8 gr float is: between 0 and +3,5 gr





# New Carp floats

Unweighted carp floats  
with PUR body

Carp floats  
with fix weight

Code: 1090

Code: 1095

Heavy-duty fishing floats with pur body, developed to carp fishing

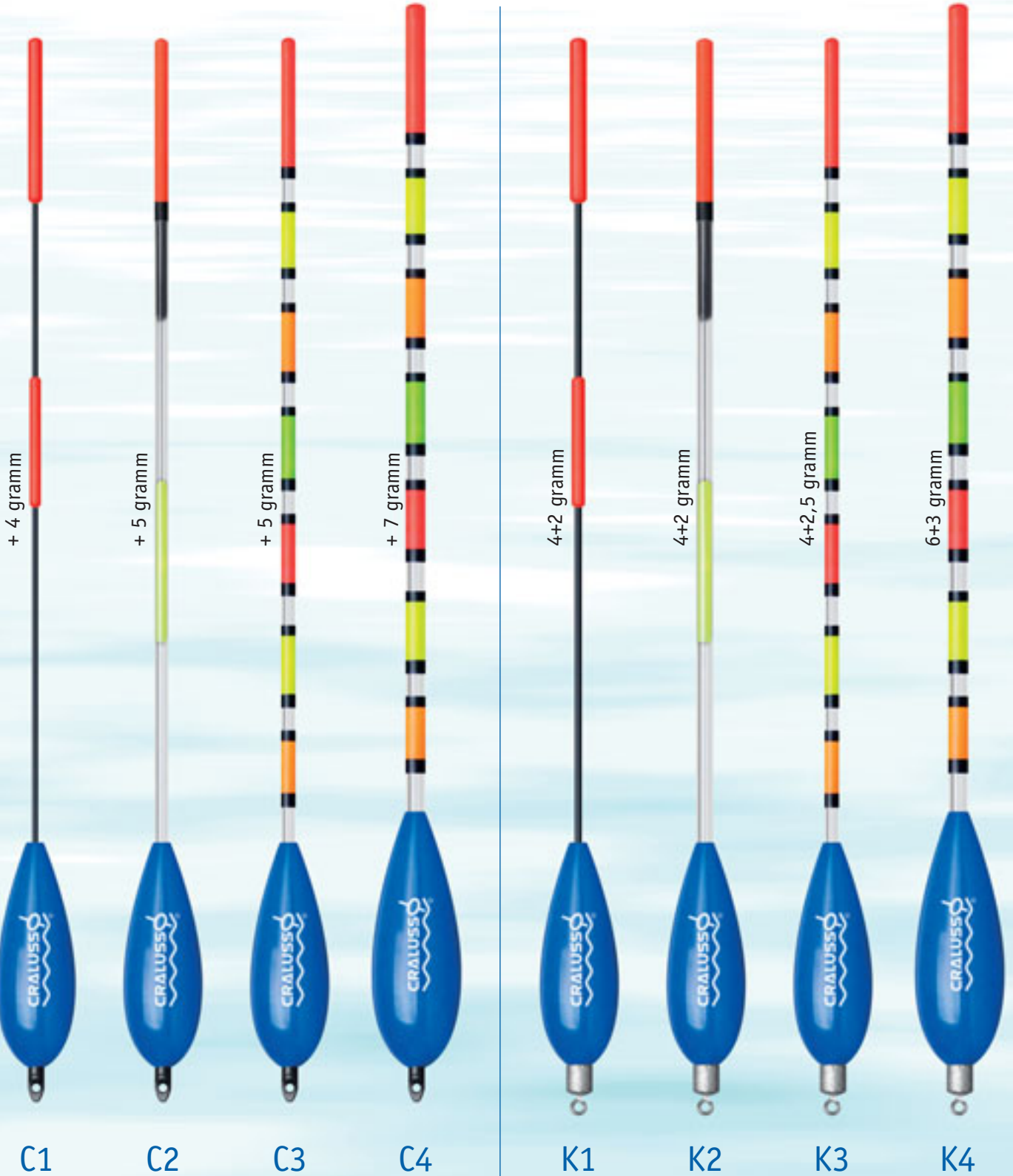

When we were creating the traditional type of tear drop floats it was our intention, as is always the company policy, to place the emphasis on making each model easy to use, infinitely variable and long lasting. The design allows all of the components, including the bristles, to be freely interchangeable thus allowing numerous combinations to be achieved. The floats are available a near transparent fibre glass stem that is less visible in water.

## Golf

Code: 1015  
(fibr glass)

The special dimpled surface of this Golf float, which reduces water tension affects, makes it an ideal choice for use on rivers, moving canals and choppy lakes.

Sizes: 1 - 1.5 - 2 - 3 - 4  
5 - 6 - 8

## Spirit

Code: 1016  
(fibr glass)

Universal shape which is ideal for both rivers and still waters. The protective plastic tube through the float is very hard wearing and makes the float virtually indestructible highly recommended when fishing for carp on the pole.

Sizes: 0,5 - 0,75 - 1  
1.5 - 2 - 3 - 4 - 5 - 6

## CAPRI

Code: 1017  
(fibr glass)

This body shape allows for more sensitive presentation even more so if you use the 1 mm carbon or glass stem as the bristle. Also incredibly strong, however, and will handle big fish well.

Sizes: 0,2 - 0,3 - 0,5 - 0,75 - 1  
1.5 - 2 - 3 - 4 - 5 - 6

They are well constructed and very strong. Bristles are interchangeable so you can make rigs that perform well for delicate presentation or dealing with big weights of fish.

They can be set up with the line through the body or externally



Components of the tear drop floats are all interchangeable and they can be assembled in a number of ways to suit your own requirements only your imagination could limit the number of variations.

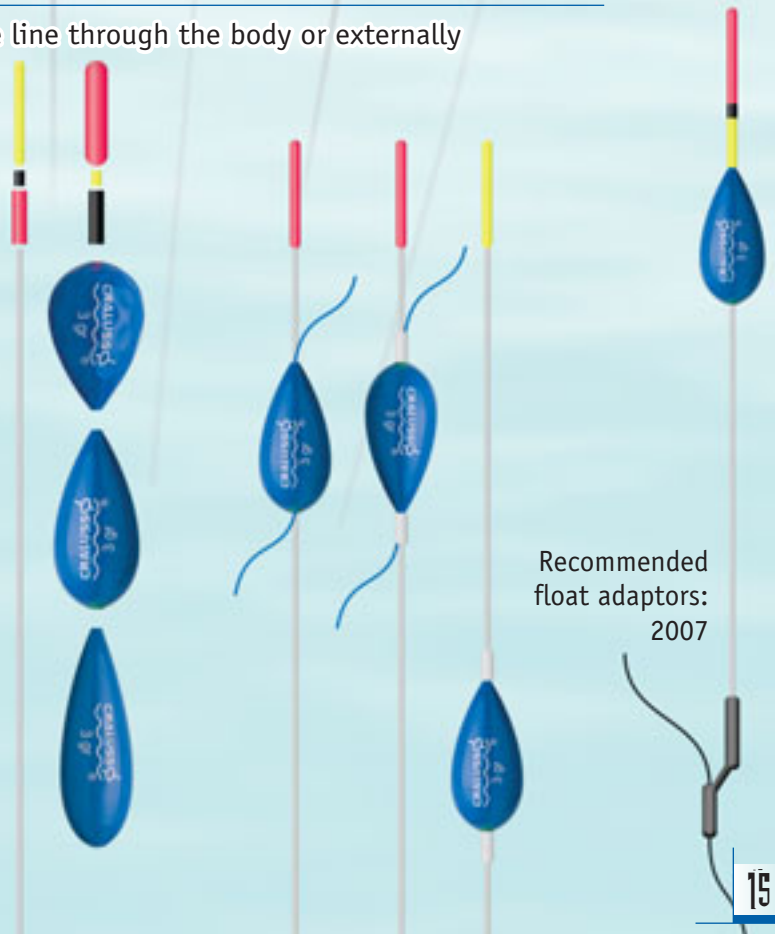

Recommended float adaptors:  
2007

## Balsa floats



Code	Weight gr	Antenna	Stem	Body mat.	Pcs/bag
1031	1-1,5	plastic	metal	balsa	5
1032	1-2-3	bamboo	metal	balsa	5
1033	1-2	plastic	metal	balsa	5

1073

## Carp Series

BALSA



Code	Weight gr	Antenna	Stem	Body mat.	Pcs/bag
1073	0,2-0,4-0,6-0,8	fix	carbon	balsa	5

## Float with balsa



Code	Weight gr	Antenna	Stem	Body mat.	Pcs/bag
1041	1-1,5-2-3-4-5	plastic	fibre glass	balsa	5
1042	0,5-0,75-1-2-3-4	plastic	fibre glass	balsa	5
1043	0,5-1,5-2	plastic	fibre glass	balsa	5
1044	0,5-1-1,5-2	fibre glass	carbon	balsa	5
1045	0,4-0,5-0,75-0,8-1-1,25-1,5-2-3	hollow	carbon	balsa	5
1046	0,8-1-1,5-2	hollow	carbon	balsa	5
1047	0,6-0,8-1-1,5-2	fibre glass	carbon	balsa	5
1048	0,4-0,6-0,8-1-1,25	fibre glass	carbon	balsa	5



## Float with balsa antenna



Code	Weight gr	Antenna	Stem	Body mat.	Pcs/bag
1060	1-2-3-4-5-6	balsa	fibre glass	balsa	5
1061	0,2-0,4-0,6-0,8-1-1,5-2-3-4-5-6	balsa	fibre glass	balsa	5
1063	0,5-1-3	balsa	fibre glass	balsa	5

## Balsa float with changeable star light antenna

**BALSA**



Code	Weight gr	Antenna	Stem	Body mat.	Pcs/bag
1205	2-3-4-5-6-8-10	plastic	fibre glass	balsa	5
1206	1-2-2,5-3-4-5-6-8	plastic	fibre glass	balsa	5
1207	1-2-3-4-5-6	plastic	fibre glass	balsa	5
1208	2-3-4-5-6	plastic	fibre glass	balsa	5

# Attachments

**2000**  
Helium-filled antenna set  
(6 pcs/bag)



**2001**  
Mixed antenna set  
(10 pcs/bag)

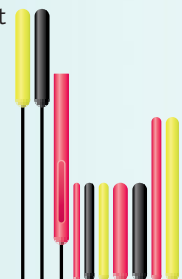

It can be used for both Cralusso Wagglers and polyurethane tear drop floats.

**2002**  
Dart antenna set  
(3 pcs/bag)



High visibility hollow antenna that aids float flight. 0,6 gr sensitivity

**2003**  
Hollow antenna set  
(6 pcs/bag)

Sensitive, highly visible hollow antenna with 0,3 gr sensitivity



**2011**  
Universal star light holder  
4,5 mm-es  
(3 pcs/bag)



**2034**  
(5 pcs/bag)



**2004**  
Waggler float stem range  
(3 pcs/bag)



**2010**  
DIY floats  
(8 pcs/bag)



**2013**  
Carbon and glass stem  
8 pcs 0,8 and 1,0 mm

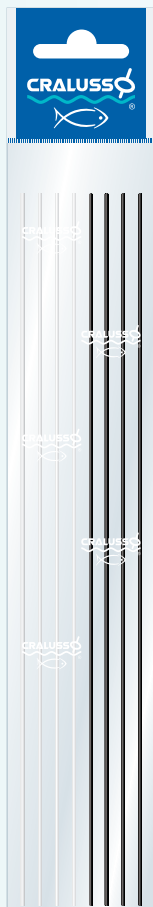

**2018**  
Dart wings (9 pcs/bag)



**2019**  
Flat antennas  
(9 pcs/bag)



## Waggler attachment Light (Fixed)

Code: 2005

A sure and safe float fixing that allows quick changes. Tangles and knots are reduced because of the built in big load bearing swivel. The attachment is very light as carbon is used in the manufacture. We offer the small Wagglers attachment for 8-10 gr floats, and the medium attachment for floats above 10 gr.

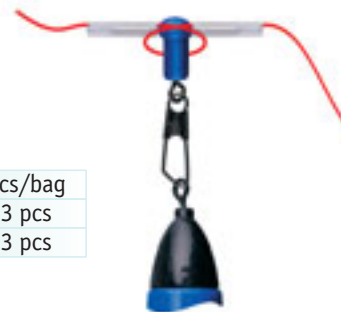

Size	Code	Weight	Pcs/bag
Small	2005	0,22 gr	3 pcs
Medium	2005	0,35 gr	3 pcs

## Anti tangle waggler attachment (Fixed)

Code: 2006

Cralusso's own development! The success of the anti-tangle waggler attachment lies in the asymmetric design which allows the device to keep the line away from the float and so greatly reduce the possibility of tangles and knots.

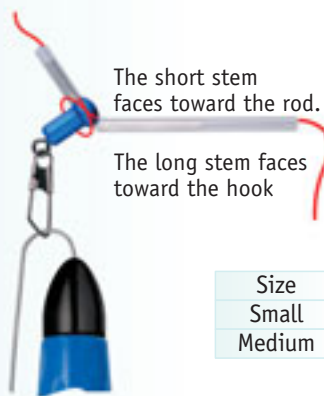

The short stem faces toward the rod.  
The long stem faces toward the hook

How to use this attachment?

Size	Code	Weight	Pcs/bag
Small	2006	0,30 gr	3 pcs
Medium	2006	0,45 gr	3 pcs

## Metal waggler snap

Code: 2035

Float fixer with ball bearing swivel, withstands the highest loads



Weight	Pcs/bag
0,30 gr	2 db

Adjustable float-holding roll

2032 S

2032 M



Adjustable roll-length

Antibacterial spray

2059



Line's sinking spray

2058



Colour antenna label

2050



Line marker

2054



2055



2056



2057





Strong silicon tubes 2009  
0,8x2,2 mm



Silicon tubes mixed  
2009-mix

Olive rubber stopper  
2008

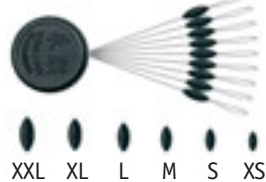

Size	Pcs/bag
XS	9 pcs
S	9 pcs
M	9 pcs
L	9 pcs
XL	9 pcs
XXL	9 pcs
mix	3x9 pcs

Size	Weight	Pcs/bag
0,5 mm	0,1 gr	4 pcs
0,7 mm	0,1 gr	4 pcs
0,9 mm	0,1 gr	4 pcs

Cylindrical rubber  
stopper  
2016

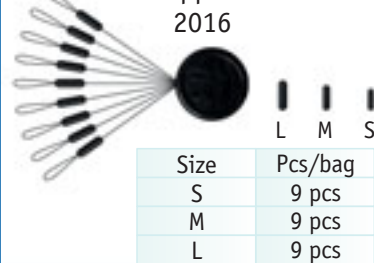

Size	Pcs/bag
S	9 pcs
M	9 pcs
L	9 pcs

Float adaptors  
For tear drop floats  
2007



Float fixing set  
2014-mix



Pellet ring 2015  
Sizes: S-M-L



Anti-tangle soft tube 2017  
0,5x1,8 - 0,8x1,9 - 1,0x2,1 mm



Bait holder 2025  
Sizes: S-L



Flare rubber thorn  
2012-mix



Pellet stopper kit  
2026 Hard



Metal bait spike 7-10 mm  
2028 S 7 mm, M 10 mm



Plastic bait spike  
2029  
S 5-7 mm, M 10-13 mm



Boilie stopper  
2027



Silicon fastened bait sting  
2030  
S 7mm - M 10mm



Hook Silicone Tube 2031  
0,3 and 0,5 mm

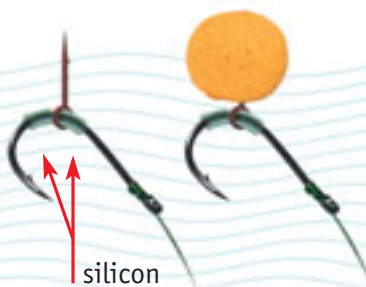

Fixing plastic bait spike  
added silicone!

“PRESTIGE” fishing line – as the name implies, this range will satisfy the highest demands of the modern angler. We believe different disciplines of fishing require a line specifically designed for the purpose and that each must possess the correct properties for its intended use. As such, we have developed and tested the lines over a period of some years and are certain we are now offering a selection of the very best available at a truly competitive price.

## Hooklength Line Soft & Strong

2061



Great attention to detail has been paid to ensure this line has the optimal relationship between strength and suppleness. It is reliable, strong and resistant to twist and tangles.

Length (m)	Diameter (mm)	Breaking Strain (kg)
50	0,088	1,18
50	0,102	1,57
50	0,123	2,34
50	0,143	3,07
50	0,160	3,84
50	0,178	4,61
50	0,201	5,71
50	0,220	6,65
50	0,250	8,30

## feeder hooklength line

2085



New generation hooklength line, which developed for the feeder fishing, this line has more stiff and stretch.

Length (m)	Diameter (mm)	Breaking Strain (kg)
50	0,14	2,94
50	0,16	3,65
50	0,18	4,00
50	0,20	5,41
50	0,22	6,22

## Brutal

2069



As its name suggests this is a hooklength line with unique strength, what is nearly invisible in the water. Made by the most modern technologies and materials. It is extremely resistant to twist and tangles.

Length (m)	Diameter (mm)	Breaking Strain (kg)
50	0,102	1,65
50	0,125	2,42
50	0,145	3,18
50	0,163	3,98
50	0,183	4,77
50	0,202	5,93
50	0,22	6,80
50	0,25	8,45

Cralusso lines = Cralusso quality!

## **XTREME** braid hooklength line

2080



This braid hooklength made of the latest technology, weaving with 8 carriers, which ensure the cyclic cross-section. Due to this technology and PE fiber are ensure the precize and maximum tensile for the lines.

Length (m)	Diameter (mm)	Breaking Strain (kg)
15	0,08	3,8
15	0,10	5,1
15	0,12	6,3
15	0,14	7,6
15	0,16	9,5

## **KEVLINE** braid hooklength line

2081



This special angling line is made from 50% Kevlar and 50% PE fibre. Sinking design, which resists damage remarkably well, and allows use under extreme conditions.

Length (m)	Breaking Strain (kg)	Breaking Strain (lb)
10	6,8	15
10	9,1	20
10	11,3	25

## **Feeder & Carp** braid hooklength line

2082



This sinking braided line concentrically woven from 8 fibres has been developed to suit the needs of Feeder and Carp anglers. Thanks to its soft and strong design it can be a reliable and favoured equipment for anglers.

Length (m)	Breaking Strain (kg)	Breaking Strain (lb)
10	4,5	10
10	6,8	15
10	9,1	20

## **FAST SINKING** braid hooklength line

2083



We focused entirely on making this angling line sink fast, nestle to the watercourse, to be undetectable by the fish and stay at the bottom.

Length (m)	Breaking Strain (kg)	Breaking Strain (lb)
10	5,4	12
10	8,1	18
10	11,3	25

**QSP**  
SYSTEM

**GENERAL**  
*Match*

2060



A very reliable line with high tensile strength Excellent UV and abrasion resistance with silky smooth surface Specially recommended for general use and rig making

Length (m)	Diameter (mm)	Breaking Strain (kg)
150	0,12	2,24
150	0,14	2,75
150	0,16	3,46
150	0,18	4,14
150	0,20	5,12
150	0,22	6,54
150	0,25	8,19
150	0,30	11,22
150	0,35	15,49

**QSP**  
SYSTEM

**Match**  
**Sinking**

2062



This new generation sinking line has been developed specifically for waggler fishing. It possesses qualities of high abrasion resistance and extremely low surface friction which enables easy casting and creates fast sink rates

Length (m)	Diameter (mm)	Breaking Strain (kg)
150	0,14	2,21
150	0,16	2,77
150	0,18	3,31
150	0,20	4,10
150	0,23	5,23
500	0,16	2,77
500	0,18	3,31
500	0,20	4,10
500	0,23	5,23

**QSP**  
SYSTEM

Unique and individual innovation made by Cralusso is the **QSP system**, which one helps to reach the optimum line filling. With this solution can avoid the multi-winding and for the reel be over or underfilled. For the **QSP system** labeled lines you can find measuring plates attached which ones support the precise loading of the reel. The QSP downloadable as an application from Google Play and App Store.

1

Please, measure the diameter and height of the spool!

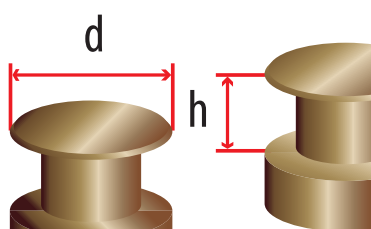

2

Please apply the measurements into the calculator that you will find on our webpage!



3

Select the appropriate value from the indicator and wind the stated amount onto the spool!



4

When you have wound the indicated amount of line onto the reel, it should be at the optimal level!

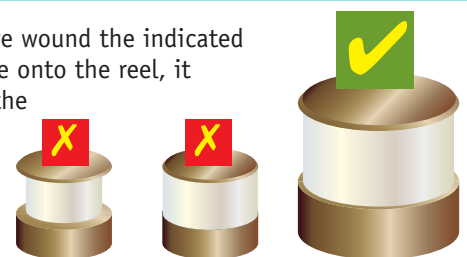

Cralusso lines = Cralusso quality!

QSP SYSTEM

**FEEDER Energy**

2063



This line is recommended for feeder fishing. It is very resilient and has a medium sink rate. The super low friction surface ensures fast movement through the water and positive contact with the fish

Length (m)	Diameter (mm)	Breaking Strain (kg)
150	0,18	4,4
150	0,20	5,5
150	0,22	6,9
150	0,25	8,6
150	0,30	11,8

**METHOD FEEDER SINKING**

2072

2073

QSP SYSTEM

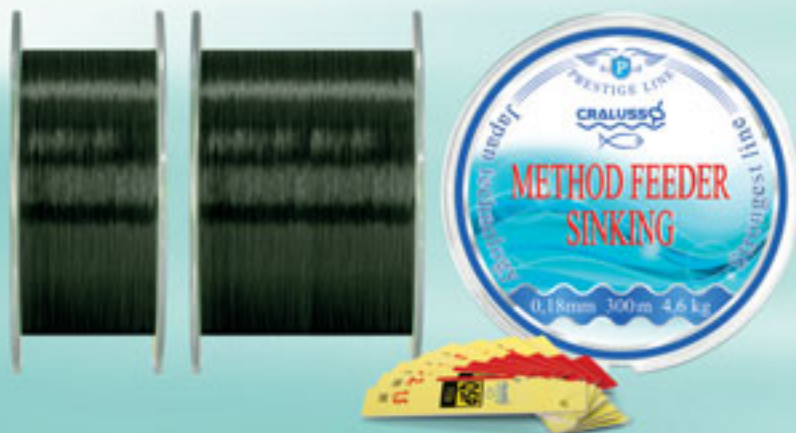

Premium quality fishing line. This high-tech copolymer fishing line produced the best results in our tests. It is a very strong, fast-sinking line with low extensibility, which, thanks to its special low-friction coating, enables 10% longer casts and an extended lifetime.

Length (m)	Diameter (mm)	Test (Kg)
300	0,18	4,6
300	0,20	5,8
300	0,22	6,9
300	0,25	8,8

Length (m)	Diameter (mm)	Test (Kg)
600	0,18	4,6
600	0,20	5,8
600	0,22	6,9
600	0,25	8,8



Caught carp with 0,14 BRUTAL hooklength line. Trust him, you'll like it!



# FLUO LINE

**QSP**  
SYSTEM

2065

2066



150 m 350 m

A reliable fishing line with high tensile strength. UV and abrasion resistant. The extraordinary smooth surface ensures effortless long range casting.

Length (m)	Diameter (mm)	Breaking Strain (kg)
150	0,18	4,4
150	0,20	5,5
150	0,22	6,9
150	0,25	8,6
150	0,30	11,8

Length (m)	Diameter (mm)	Breaking Strain (kg)
350	0,18	4,4
350	0,20	5,5
350	0,22	6,9
350	0,25	8,6
350	0,30	11,8

# FEEDER & CARP

2095

2096

150 m

300 m



This low-stretch line specially developed for feeder and carp fishing. The fluoro carbon coating guarantee longer casting distance and faster sinking.

Length (m)	Diameter(mm)	Test (Kg)	Fish test (Kg)
150	0,18	2,8	5,1
150	0,20	3,4	6,5
150	0,22	4,0	7,3
150	0,25	5,1	9,5
150	0,30	7,2	13,0

300	0,18	2,8	5,1
300	0,20	3,4	6,5
300	0,22	4,0	7,3
300	0,25	5,1	9,5
300	0,30	7,2	13,0

# Infinity

2071



This line is recommended for feeder and carp fishing. It has a medium sink rate, high abrasion resistance and very low surface friction that assists with long range casting and minimal damage.

Length (m)	Diameter (mm)	Breaking Strain (kg)
500	0,20	5,1
500	0,22	6,5
500	0,25	8,2
500	0,30	11,2

Cralusso lines = Cralusso quality!

# DOMINATOR X8

2067



Fine-woven, quiet, moderately soft-braided fishing line with high tensile strength, wear-resistant surface and zero elongation. Thanks to its thin, special coating, it slides quietly and easily between the rings. Thus, it allows longer casts for spinning anglers even with lighter baits.

Length (m)	Diameter (mm)	Breaking Strain (kg)
100	0,10	5,8
100	0,12	6,9
100	0,15	8,7
100	0,18	11,4
100	0,20	14,2

# Fluoro Carbon Line

2090



Fluoro carbon is being nearly invisible in water and this 100% fluoro carbon exceeds all expectations. It has a low stretch and fast sinking rate.

Length (m)	Diameter (mm)	Breaking Strain (kg)
30+10	0,14	1,92
30+10	0,16	2,52
30+10	0,18	3,09
30+10	0,20	3,90
30+10	0,22	5,06
30+10	0,25	6,12
30+10	0,30	7,55
30+10	0,40	14,55
30+10	0,50	20,24



## NAVIGATOR



**Feeder Energy**  
(200m) with QSP

2077



The **Navigator** Feeder fishing line provides great opportunities for both carp and feeder anglers.

Short and long range distances, features and clipping up points are easily identified and there is no problem if you use two or more rods. The line is marked every 5m and this will assist you to fish accurately at the same distance. Please look at the diagram and further information can be found on our webpage.

This line was developed in accordance with the requirements of high profile carp and feeder anglers - it is extremely strong, has a medium sink rate, possesses high tensile strength with low stretch and is an easily managed.

**THE SOLUTION: The QSP system** which is only provided by Cralusso! It will help to avoid the need for multiple attempts at filling spools accurately. You will find the description on page 30 and further information on our webpage.

QSP QR CODE



Length (m)	Diameter (mm)	Breaking Strain (kg)
200	0,18	4,40
200	0,20	5,51
200	0,22	6,90
200	0,25	8,60



## CARPower feederGUM

2098



Recommend to the following line thicknesses:

Length (m)	Diameter (mm)	Monofil	Braided (mm)
10	0,65	0,12-0,18	0,06-0,10
10	0,80	0,18-0,25	0,10-0,16
10	1,00	0,25-0,35	0,16-0,22



# Hooks

## Sode Light

2401



Flatted – Forged – Round  
Slim stemmed easy hook



Size	18	16	14	12	10	8	6	4	2
<i>Hooklength</i> <i>Line</i> <small>Soft &amp; Strong</small>	0,10-0,11	0,11-0,12	0,12	0,13	0,14	0,14	0,16	0,18	0,20
Weight (gr)	0,004	0,005	0,008	0,012	0,017	0,023	0,05	0,09	0,12
Diameter (mm)	0,27	0,28	0,33	0,37	0,41	0,49	0,57	0,72	0,76
Pcs/bag	14	14	16	16	16	16	14	14	14



## Chika

2405



Flatted – Round



Size	18	16	15	14	12	10	8
<i>Hooklength</i> <i>Line</i> <small>Soft &amp; Strong</small>	0,10	0,10-0,11	0,12	0,12	0,12-0,13	0,13-0,14	0,14
Weight (gr)	0,005	0,008	0,011	0,014	0,018	0,024	0,029
Diameter (mm)	0,28	0,33	0,36	0,39	0,43	0,46	0,48
Pcs/bag	16	16	16	16	14	14	14



## Koaji Round

2410



## Koaji Round Brass

2411

Flatted – Round



Size	16	14	12	10	8
<i>Hooklength</i> <i>Line</i> <small>Soft &amp; Strong</small>	0,10-0,11	0,12	0,14	0,14-0,15	0,16
Weight (gr)	0,009	0,016	0,023	0,036	0,049
Diameter (mm)	0,33	0,41	0,46	0,54	0,60
Pcs/bag	16	16	14	14	14



## Shin Aji

2415



Flatted – Large Forged



Size	11	9	7	5
<i>Hooklength</i> <i>Line</i> <small>Soft &amp; Strong</small>	0,18	0,20	0,25	0,30
<b>X</b> <i>TREME</i>	0,10	0,12	0,16	0,18
Weight (gr)	0,045	0,066	0,094	0,14
Diameter (mm)	0,57	0,64	0,72	0,81
Pcs/bag	11	10	9	8



# Hooks

## Umi Tango

2420

Flatted – Forged



Size	16	14	12	10	8	6
<i>Hooklength</i> <i>Line</i> <small>Soft &amp; Strong</small>	0,12	0,12-0,14	0,14-0,16	0,16	0,18	0,18-0,20
<b>X</b> XTREME				0,08	0,10	0,10-0,12
Weight (gr)	0,014	0,024	0,034	0,051	0,083	0,103
Diameter (mm)	0,39	0,46	0,51	0,57	0,68	0,72
Pcs/bag	12	12	12	12	11	10



## SB Chinu

2430

Double (one normal and one micro) edge point  
– Flatted – Forged and Curved



Size	10	8	6	4	2
<i>Hooklength</i> <i>Line</i> <small>Soft &amp; Strong</small>	0,20	0,22	0,25	0,30	0,32-0,35
<b>X</b> XTREME	0,12-0,14	0,14	0,16	0,18	
Weight (gr)	0,049	0,061	0,077	0,134	0,2
Diameter (mm)	0,6	0,68	0,72	0,86	0,99
Pcs/bag	10	10	9	9	7



## Delta Chinu

2435

Triple edge point – Trust Grip – Forged and Curved

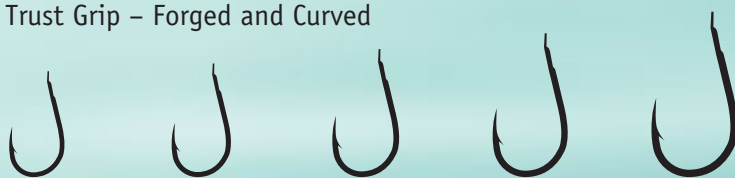

Size	10	8	6	4	2
<i>Hooklength</i> <i>Line</i> <small>Soft &amp; Strong</small>	0,18	0,20	0,22-0,25	0,25-0,30	0,30-0,35
<b>X</b> XTREME	0,10	0,12-0,14	0,14-0,16	0,16-0,18	
Weight (gr)	0,048	0,070	0,084	0,137	0,198
Diameter (mm)	0,6	0,68	0,72	0,86	0,99
Pcs/bag	8	8	8	7	6



## Chinu W/Ring

2440

With PTFE coat



Size	10	8	6	4	2
<i>Hooklength</i> <i>Line</i> <small>Soft &amp; Strong</small>	0,18	0,20	0,22-0,25	0,25-0,30	0,30-0,35
<b>X</b> XTREME	0,10	0,12-0,14	0,14-0,16	0,16-0,18	0,18
Weight (gr)	0,063	0,082	0,10	0,15	0,23
Diameter (mm)	0,6	0,68	0,72	0,86	0,99
Pcs/bag	14	14	13	12	10





# Hooks



The biggest fish at the 2014 world championship held in Croatia, a 4,6kg barbel was caught on the fast-flowing Drava by Arjan Klop, member of the world champion Dutch team using our 2445 Chinu hook. This hook has also proven its worth many times! Made of forged Japanese steel, extremely sharp, despite its medium thick stem it is remarkably strong. A reliable companion during tiring.

## Chinu

2445

Brass



Size	12	11	10	8	6
<i>Hooklength</i> <i>Line</i> <small>Soft &amp; Strong</small>	0,18	0,20	0,22-0,25	0,25-0,30	0,30-0,35
<del>XTREME</del>	0,10	0,12-0,14	0,14-0,16	0,16-0,18	0,18
Weight (gr)	0,031	0,039	0,048	0,066	0,079
Diameter (mm)	0,6	0,68	0,72	0,86	0,99
Pcs/bag	14	14	14	14	14



## Maruseigo horog

2450

With PTFE coat

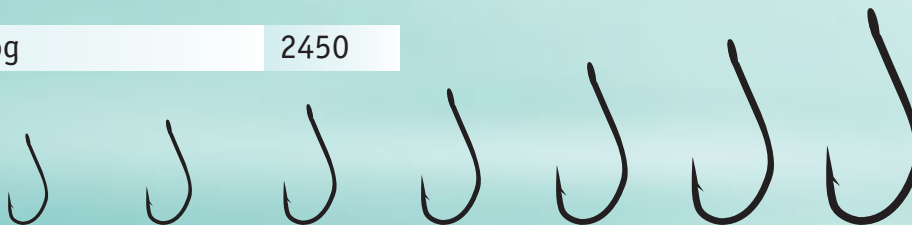

Size	14	12	10	8	6	4	2
<i>Hooklength</i> <i>Line</i> <small>Soft &amp; Strong</small>	0,20	0,22	0,28	0,35	0,40	0,40	0,45
<del>XTREME</del>	0,12-0,14	0,14	0,16-0,18				
Weight (gr)	0,031	0,048	0,071	0,104	0,156	0,236	0,367
Diameter (mm)	0,6	0,68	0,72	0,86	0,99	1,06	1,13
Pcs/bag	12	11	11	10	9	8	7



## Gripper Carp

2455

With PTFE coat



Size	8	6	4
Recommended max. line strength	18 lb	20 lb	22 lb
Weight (gr)	0,18	0,24	0,29
Diameter (mm)	0,94	0,98	1,10
Pcs/bag	8	8	8



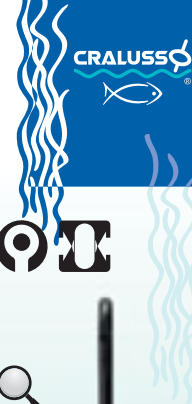

# Hooks

## Boilie Carp

2460

With PTFE coat

Size	8	6	4
Recommended max. line strength	17 lb	24 lb	30 lb
Weight (gr)	0,092	0,145	0,224
Diameter (mm)	0,78	0,89	1,03
Pcs/bag	8	8	8



## Anti Snag

2465

With PTFE coat

Size	8	6	4	2
Recommended max. line strength	18 lb	23 lb	34 lb	37 lb
Weight (gr)	0,17	0,22	0,37	0,40
Diameter (mm)	0,98	1,03	1,22	1,26
Pcs/bag	8	8	8	8



## CARPower

2470

With PTFE coat



Size	14	12	10	8	6	4	2
Recommended max. Monofil line	0,20	0,22	0,25	0,28	0,32	0,35	0,38
Recommended max. braided line	0,12	0,14	0,16	0,18	0,20	0,20	0,22
Weight (gr)	0,028	0,03	0,043	0,054	0,092	0,131	0,23
Diameter (mm)	0,48	0,52	0,62	0,75	0,85	0,951	1,06
Pcs/bag	12	12	12	12	12	12	10



## CARpmagnet Barbless

2472

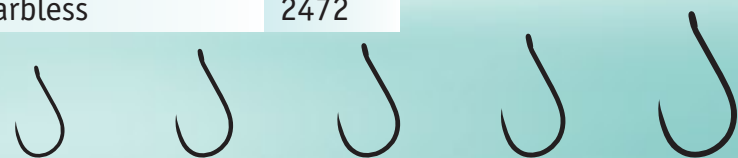

Size	12	10	8	6	4
<i>Hooklength Line</i> Soft & Strong	0,22	0,25	0,28	0,30	0,35
<del>XTREME</del>	0,14	0,16	0,18	0,2	0,22
Weight (gr)	0,049	0,075	0,093	0,107	0,167
Diameter (mm)	0,64	0,72	0,76	0,81	0,92
Pcs/bag	12	12	12	12	12



## Zander-worm

2480



Size	2	1	1/0	2/0
Weight (gr)	0,219	0,272	0,338	0,439
Diameter (mm)	0,86	0,92	0,99	1,07
Pcs/bag	8	8	8	8





# Quality swivels and accessories at a reasonable price!

Rolling swivel, black

2109



Size	Test	Weight	Pcs/bag
3/0	100 kg	1,82 gr	3 pcs
2/0	75 kg	1,28 gr	4 pcs
1/0	60 kg	0,90 gr	5 pcs
2	43 kg	0,53 gr	6 pcs
4	35 kg	0,33 gr	8 pcs
6	30 kg	0,19 gr	12 pcs
8	19 kg	0,12 gr	12 pcs
10	14 kg	0,07 gr	12 pcs
12	9 kg	0,06 gr	12 pcs

Golden swivel

2110

Exclusive design



Size	Test	Weight	Pcs/bag
3	40 kg	0,41 gr	10 pcs
5	32 kg	0,25 gr	12 pcs
7	22 kg	0,13 gr	12 pcs
10	14 kg	0,07 gr	12 pcs
14	4 kg	0,04 gr	12 pcs

Rhombus swivel

2111



Size	Test	Weight	Pcs/bag
5	27 kg	0,25 gr	12 pcs
7	19 kg	0,13 gr	12 pcs
10	9 kg	0,07 gr	12 pcs
12	6 kg	0,06 gr	12 pcs
14	4 kg	0,04 gr	12 pcs

Double swivel

2112



Size	Test	Weight	Pcs/bag
5	32 kg	0,44 gr	12 pcs
7	22 kg	0,25 gr	12 pcs
10	14 kg	0,13 gr	12 pcs
12	8 kg	0,09 gr	12 pcs
14	4 kg	0,06 gr	12 pcs

Triple speed swivel

2113



Size	Test	Weight	Pcs/bag
7	22 kg	0,23 gr	12 pcs
10	14 kg	0,112 gr	12 pcs
12	8 kg	0,10 gr	12 pcs
14	4 kg	0,062 gr	12 pcs

Triple chain swivel

2114



Size	Test	Weight	Pcs/bag
7	22 kg	0,23 gr	12 pcs
10	14 kg	0,112 gr	12 pcs
14	4 kg	0,062 gr	12 pcs

Swivel & safety snap

2115



Size	Test	Weight	Pcs/bag
5	9 kg	0,40 gr	12 pcs
7	7 kg	0,23 gr	12 pcs
10	5 kg	0,14 gr	12 pcs
14	3 kg	0,10 gr	12 pcs

Crane swivel with interlock snap

2116



Size	Test	Weight	Pcs/bag
2	18 kg	0,52 gr	10 pcs
4	14 kg	0,38 gr	12 pcs
6	12 kg	0,26 gr	12 pcs
8	10 kg	0,16 gr	12 pcs
10	9 kg	0,12 gr	12 pcs

Double rolling swivel with interlock snap

2150



Size	Test	Weight	Pcs/bag
6	12 kg	0,43 gr	6 pcs
8	10 kg	0,26 gr	6 pcs
10	10 kg	0,20 gr	6 pcs
12	7 kg	0,15 gr	6 pcs



# Quality swivels and accessories at a reasonable price!

Swivel with hooked snap

2117



Size	Test	Weight	Pcs/bag
5	28 kg	0,55 gr	12 pcs
7	20 kg	0,25 gr	12 pcs
10	12 kg	0,13 gr	12 pcs
14	4 kg	0,06 gr	12 pcs

Ball bearing swivel with snap

2118



Size	Test	Weight	Pcs/bag
0	12 kg	0,32 gr	6 pcs
1	18 kg	0,52 gr	6 pcs
2	25 kg	0,76 gr	6 pcs
4	35 kg	1,60 gr	6 pcs

Swing coastlock snap

2119



Size	Test	Weight	Pcs/bag
6	30 kg	0,32 gr	12 pcs
8	19 kg	0,20 gr	12 pcs
10	14 kg	0,12 gr	12 pcs
12	9 kg	0,08 gr	12 pcs

Side-line rolling swivel

2120



Size	Test	Weight	Pcs/bag
2	43 kg	0,88 gr	6 pcs
4	35 kg	0,56 gr	6 pcs
6	30 kg	0,32 gr	6 pcs
8	19 kg	0,18 gr	6 pcs

Corner plate swivel

2121

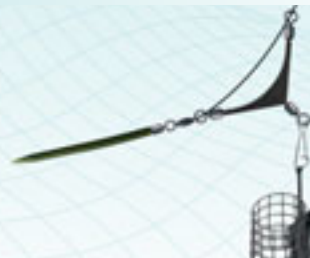

Size	Weight	Pcs/bag
6	1,3 gr	3 pcs
8	0,94 gr	3 pcs
10	0,57 gr	3 pcs

Brass Head Safety Snap

2122



Size	Weight	Pcs/bag
S	0,17 gr	6 pcs
M	0,26 gr	6 pcs

Plastic head swivel with interlock snap

2123



Size	Weight	Pcs/bag
S	0,15 gr	6 pcs
M	0,23 gr	6 pcs

Self-lock rotating snap

2124



Size	Test	Weight	Pcs/bag
4/0	90 kg	3,50 gr	4 pcs
2/0	70 kg	1,84 gr	6 pcs
1	55 kg	1,06 gr	10 pcs
3	40 kg	0,67 gr	10 pcs
5	30 kg	0,43 gr	12 pcs
7	15 kg	0,24 gr	12 pcs
10	10 kg	0,14 gr	12 pcs

Hooked snap

2125



Size	Test	Weight	Pcs/bag
00	9 kg	0,03 gr	12 pcs
0	12 kg	0,04 gr	12 pcs
1	20 kg	0,08 gr	12 pcs
2	28 kg	0,13 gr	12 pcs
3	35 kg	0,20 gr	12 pcs



# Quality swivels and accessories at a reasonable price!

Rolling swivel with nice snap

2127



Size	Test	Weight	Pcs/bag
4/0	70 kg	2,05 gr	4 pcs
2/0	44 kg	1,45 gr	6 pcs
1	38 kg	0,92 gr	10 pcs
3	33 kg	0,68 gr	12 pcs
5	27 kg	0,44 gr	12 pcs
7	20 kg	0,27 gr	12 pcs
10	12 kg	0,13 gr	12 pcs

Quick snap with fixing tube

2128



Size	Pcs/bag
6	6 pcs
8	6 pcs

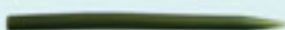

Safety lead snap kit

2130

2x6 pcs/bag



Swivel with pearl beads and rubber stopper

2129

Size	Pcs/bag
M	2x4 pcs



Slipping feeder fixing set

2131

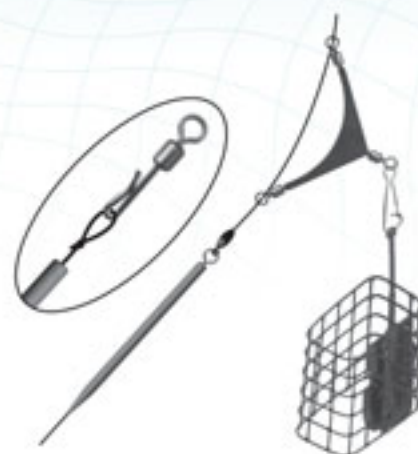
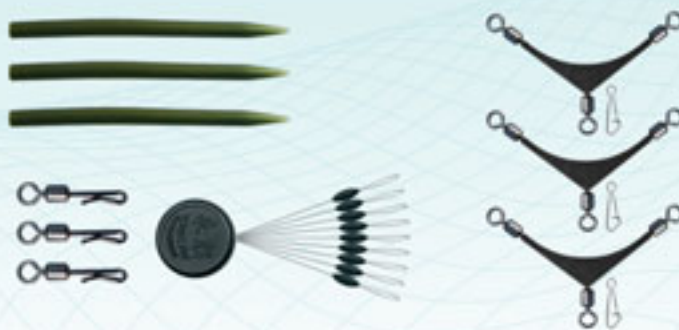

# Quality swivels and accessories at a reasonable price!

## Match Quick snap

2132



Size	Pcs/bag
8	6 pcs
10	6 pcs
12	6 pcs
14	6 pcs

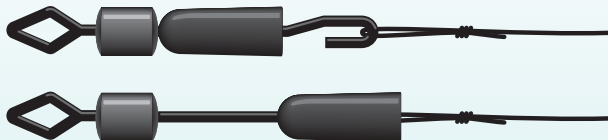

## Swivel with side line clip

2135



Size	Test	Weight	Pcs/bag
8	14 kg	0,20 gr	12 pcs
10	9 kg	0,12 gr	12 pcs
12	4 kg	0,08 gr	12 pcs

## Rolling quick snap

2134



Size	Test	Weight	Pcs/bag
8	9 kg	0,16 gr	6 db
10	7 kg	0,1 gr	6 db
12	5 kg	0,06 gr	6 db
14	3 kg	0,04 gr	6 db

## Double quick snap swivel

2136



Size	Test	Weight	Pcs/bag
8	9 kg	0,24 gr	6 db
10	7 kg	0,15 gr	6 db
12	5 kg	0,1 gr	6 db
14	3 kg	0,06 gr	6 db

## Feeder quick snap

2133



M 6 pcs/bag

## Soft beads

2141

1,2×6mm  
8 pcs/bag



## Not-A-Knot swivel

2146



XXL 40 kg 6 pcs/bag

## Maggot clips

2145

11×14×0,5 mm  
6 pcs/bag



## Method power quick snap

2137

Most powerful method snap



Size	Test	Weight	Pcs/bag
8	9 kg	0,36 gr	6 db

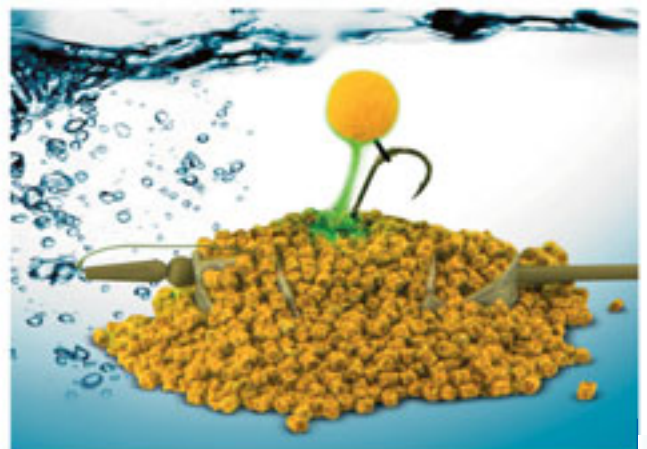

# Distance holders, Fixing wedges

Fixing Wedge

2201

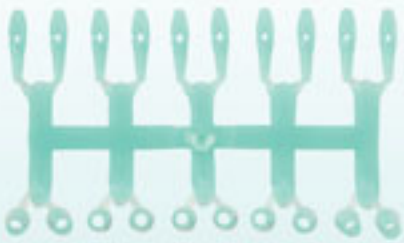

(L)



1 pcs/bag

Full stop arrester

2203

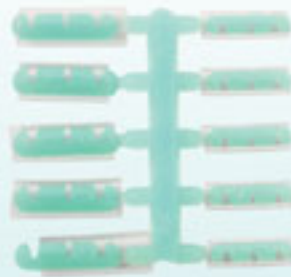

1 pcs/bag



Tackle box 2 compartments

2225



Tackle box 4 compartments

2230



Tackle box 6 compartment

2235



## Pop up, Suspended, solvable and smoking mini boilies



Code	Size	Weight	Flavor
2600	8 mm	20 gr	Pineapple
2605	8 mm	20 gr	Strawberry
<b>NEW</b> 2606	8 mm	20 gr	Chocolate-mango
2620	8×12 mm	20 gr	Pineapple
2625	8×12 mm	20 gr	Strawberry
<b>NEW</b> 2626	8×12 mm	20 gr	Chocolate-mango
2640	12 mm	40 gr	Pineapple
2645	12 mm	40 gr	Strawberry

## Pop up, Fluo mini boilie



Code	Size	Weight	Flavor
<b>NEW</b> 2665	10 mm	40 gr	Fluo pineapple
2666	10 mm	40 gr	Chocolate-mango
2678	12 mm	40 gr	Fluo pineapple

## Pop up white mini boilie



Code	Size	Weight	Flavor
2680	8 mm	20 gr	Garlic
2685	8 mm	20 gr	N-Butyric acid
2690	12 mm	40 gr	Garlic
2695	12 mm	40 gr	N-Butyric acid

## Balanced wafers mini boilie



Code	Size	Weight	Flavor
2740	6×7 mm	20 gr	Strawberry
2743	6×7 mm	20 gr	Corn
2744	7 mm	20 gr	Chocolate-Orange
2745	7 mm	20 gr	Mango
2750	7×9 mm	20 gr	Pineapple
2751	7×9 mm	20 gr	Strawberry
2752	7×9 mm	20 gr	Garlic
<b>NEW</b> 2756	7×9 mm	20 gr	Mango
2753	9×11 mm	40 gr	Fluo pineapple
2754	9×11 mm	40 gr	N-butyric acid
<b>NEW</b> 2755	9×11 mm	40 gr	Mango

## Ready to go mini boilie



Code	Size	Weight	Flavor
2760	8 mm	20 gr	Pineapple - Pop up
2761	8 mm	20 gr	Garlic - Pop up
<b>NEW</b> 2762	7×9 mm	20 gr	Mango - Wafers
<b>NEW</b> 2763	7×9 mm	20 gr	N-butyric acid - Wafers
<b>NEW</b> 2764	9×11 mm	40 gr	Corn - Balanced
<b>NEW</b> 2765	9×11 mm	40 gr	Mango - Wafers
2767	12 mm	40 gr	Fluo pineapple - Pop up

No need to bother anymore with mounting, just hang up the balanced hooklength into the method snap from the box. The hook and the bait size, thickness of hooklength and balance lead harmonize with each other what is one of the main part of successful fishing. Contains one prepared hooklength per box.



## Hook bait and pellets



### Jelly Corn

Baits of human food quality, with added vitamins.

Flexible corn developed using raw materials approved by the Aquaculture Department of Szent István University; fully biodegradable and digestible for fish. The vitamin-enriched, coloured and flavoured corns are quick to attract fish, making them an excellent bait. Just stick it on your hook, bait pin or boilie stopper. You'll find corns of three different sizes in your box. These baits, made from dyed natural input materials do not stain your hands. They dry and shrink a little if left in open air, while in water they swell somewhat.



**NOT PLASTIC!**

Scientists estimate that for conventional plastic corn baits it takes about 500 years to decompose!

**LET'S PROTECT THE ENVIRONMENT AND FISH!**

Code	Colour	Flavor	Pcs/bag
2505	yellow	Pineapple	30 pcs
2506	red	Strawberry	30 pcs
2507	orange	chocolate-orange	30 pcs
2520	white	N-butyric acid	30 pcs
2521	pink	Pepper sausage	30 pcs
2522	yellowish green	Garlic	30 pcs
2523	green	brandy corn	30 pcs

### Jelly Shell



**NOT PLASTIC**  
Full natural!

Code	Colour	Flavor	Pcs/bag
2530	white	shell	30 pcs
2531	yellow	vanilla	30 pcs
2532	red	anise	30 pcs
2533	orange	chocolate-orange	30 pcs
2534	yellow	pineapple	30 pcs
2535	green	garlic	30 pcs

### Jelly Snail NEW



**NOT PLASTIC**  
Full natural!

Code	Colour	Flavor	Pcs/bag
2540	yellow	pineapple	30 pcs
2541	red	strawberry	30 pcs
2542	orange	mango	30 pcs
2543	brown	cocoa	30 pcs
2544	white	N-butyric acid	30 pcs
2545	yellowish green	garlic	30 pcs



# FISHING MASTER

## Aroma spray

Code	Flavor	L. measure
2850	Fluo pineapple	50 ml
2855	Strawberry	50 ml
2865	Garlic	50 ml
2870	Pepper sausage	50 ml
2875	Squid, octopus	50 ml



# FISHING MASTER

## Method gel

Code	Flavor	Weight
2880	Fluo pineapple	100 gr
2881	Strawberry	100 gr
2882	Caramel	100 gr
2883	Garlic	100 gr
2884	Fluo squid octopus	100 gr
2885	Cheese	100 gr





# Tripod

Tripod, telescopic  
Stainless steel

Adjustable tripod set  
Stainless steel



# Telescopic bankstick

Stainless steel  
telescopic bankstick



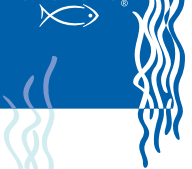

## Buzz bar

Adjustable buzz bar 40cm

3575



Stainless steel telescopic buzz bar  
30-50cm

3590



## Feeder rod rest

3670



Unique, velvety protective surface

3671



3675

Method rod rest "M"



3676

Method rod rest "L"



3675

3500



## Rod rest heads



3616

## Rod rest



3621



3631



3650



3655



3660

## Rod rest



3635



3636



# Feeder Basket

## Method basket plated

(packing bag)

3205



LEAD FREE

Code	Weight	Pcs/bag
3205-20	20 gr	2 pcs
3205-25	25 gr	2 pcs
3205-30	30 gr	2 pcs

## Method basket stemmed

(packing bag)

3210



LEAD FREE

Code	Weight	Pcs/bag
3210-20	20 gr	2 pcs
3210-25	25 gr	2 pcs
3210-30	30 gr	2 pcs
3210-40	40 gr	2 pcs

## Eco method basket set

3250

Set:

EXC method feeder 20 g – 1 pcs

EXC method feeder 30 g – 1 pcs

EXC method modul – 1 pcs

Rolling swivel 10 – 2 pcs



## Method basket charger

3215

1 pcs/bag  
(packing bag)



## Aerowinged basket

(packing bag)

3280



LEAD FREE

Code	Weight	Pcs/bag
3280-20	20 gr	2 pcs
3280-30	30 gr	2 pcs
3280-40	40 gr	2 pcs

## Vario feeder 2 in 1 basket

3290

2 pcs/bag



Code	Weight	Pcs/bag
3290-20	20 gr	2 pcs
3290-30	30 gr	2 pcs
3290-40	40 gr	2 pcs

## Feeder Basket

Protected product!

Pop-up feeder basket fix

3295



The pop-up feeder basket weighs only 2 grams. Filled with feed, it sinks to the bottom and stays there until much of the feed is dissolved. Thereafter, its light buoyancy brings it slowly towards the surface, 'scanning' through the entire water column. Takes may be expected in multiple phases, either in midwater, with the bait sinking slowly together with the basket, or lying on the bottom, but often it is the bait rising up to midwater that triggers an intensive take. The speed of sinking or rising can be controlled thanks to the adjustable design.

Pop-up feeder basket adjustable

3296

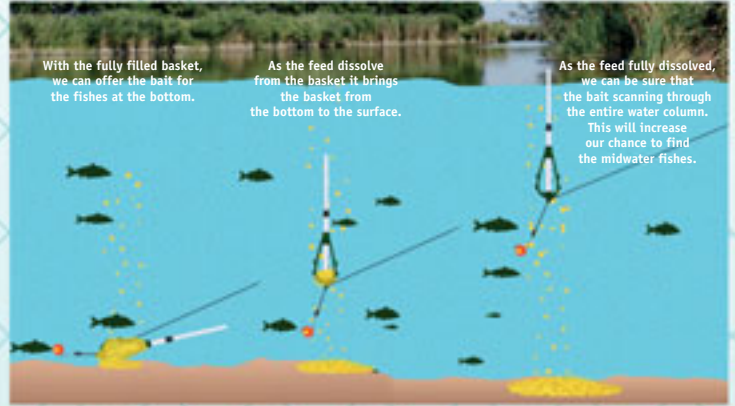
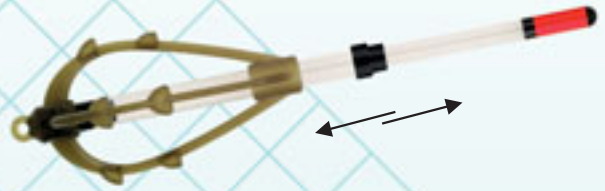

Zero Weightless Feeder basket

3297

NEW



## New generation method baskets and fillers

A unique innovation: patented Cralusso method baskets with longitudinal ribs. Thanks to its special design the hook is less likely to become attached to the

longitudinal ribs and it perfectly retains the feed as long as necessary and quickly releases it in the water. With its centre of gravity close to its front end it is particularly suitable for long and accurate throws. You can replace your feeder basket with one of a different size simply and quickly, without having to take apart your tackle.

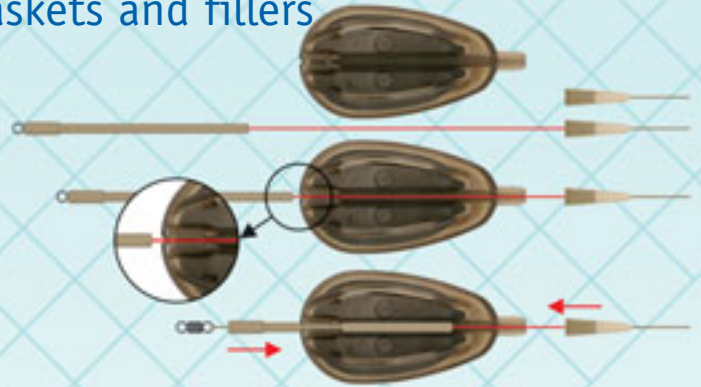

Sensitive method basket

3300



Code	Weight	Pcs/bag
3300-30	30 gr	1 pcs
3300-40	40 gr	1 pcs
3300-50	50 gr	1 pcs
3300-70	70 gr	1 pcs

Rocket method basket

3305



Code	Weight	Pcs/bag
3305-30	30 gr	1 pcs
3305-40	40 gr	1 pcs
3305-50	50 gr	1 pcs
3305-70	70 gr	1 pcs

# Feeder baskets



Fluo Green Rocket Method basket

3306

Plastic-free packaging



Code	Weight	
3306-30	30 gr	Fluo Green Rocket Method basket
3306-40	40 gr	Fluo Green Rocket Method basket
3306-50	50 gr	Fluo Green Rocket Method basket
3306-60	60 gr	Fluo Green Rocket Method basket

Orange Rocket Method basket

3307

Plastic-free packaging



Code	Weight	
3307-30	30 gr	Orange Rocket Method basket
3307-40	40 gr	Orange Rocket Method basket
3307-50	50 gr	Orange Rocket Method basket
3307-60	60 gr	Orange Rocket Method basket

Pink Rocket Method basket

3308

Plastic-free packaging



Code	Weight	
3308-30	30 gr	Pink Rocket Method basket
3308-40	40 gr	Pink Rocket Method basket
3308-50	50 gr	Pink Rocket Method basket
3308-60	60 gr	Pink Rocket Method basket

Crystal Rocket Method basket

3309

Plastic-free packaging



Code	Weight	
3309-30	30 gr	Crystal Rocket Method basket
3309-40	40 gr	Crystal Rocket Method basket
3309-50	50 gr	Crystal Rocket Method basket
3309-60	60 gr	Crystal Rocket Method basket

Method basket stem set

3345

5 pcs/bag



# DOUBLE CHANCE method, a unique Innovation for catching more fish!

Duble Chance Method basket

3315

Code	Weight	Pcs/bag
3315-30	30 gr	1 pcs
3315-40	40 gr	1 pcs
3315-50	50 gr	1 pcs
3315-70	70 gr	1 pcs



The Double Chance Method basket is Cralusso's latest, unique development. Use the newly developed basket for even more successful fishing! Two baits, of different flavours and buoyancies can be presented simultaneously to find the day's winner bait. When you pull out your rig after an unfinished or a missed take and check the hooklength (long one, see the drawing), you'll see which bait attracted the fish. While playing a hooked fish the other hook safely retracts into the basket tube – to keep the fish from being harmed and avoid getting the hook caught in rocks or vegetation in the water.



### Assembling

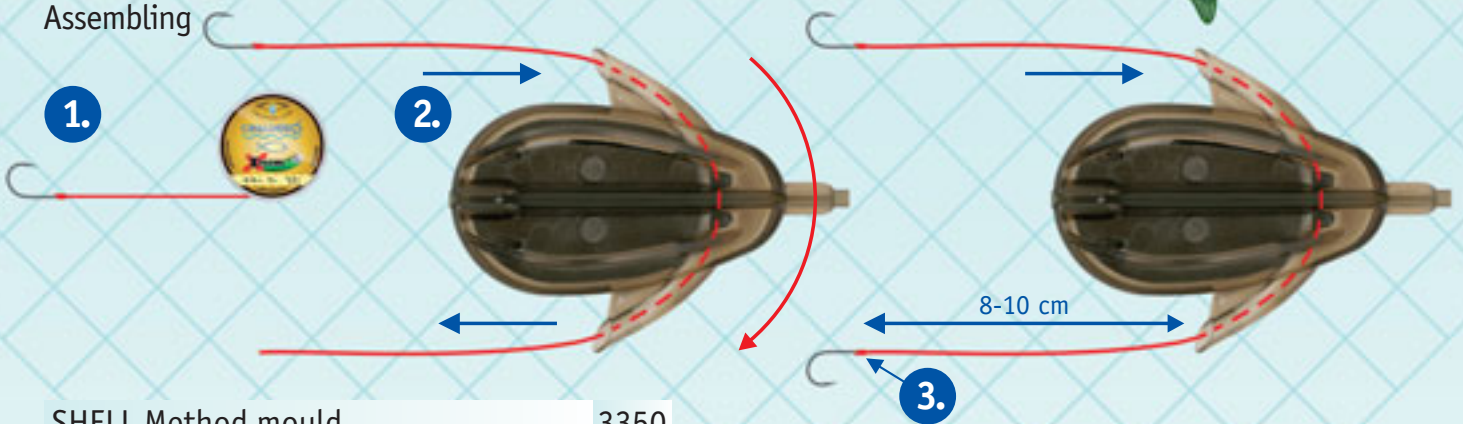

SHELL Method mould

3350



We recommend that you use 3350 Blue Shell Method filling device for filling Double Chance feeder baskets. The gaps on the side of the openable device accommodate the two lateral wings of the Double Chance basket. The Blue Shell method feeder basket filling device provides for simple and quick filling, and the feeding stuff will never stick to it. You simply open the device off the filled basket.



# Method packages

Sensitive package

3360



Code	Weight	Pcs/bag
3360-30	30 gr	2 pcs
3360-40	40 gr	2 pcs
3360-50	50 gr	2 pcs
3360-70	70 gr	2 pcs

Double Chance Method basket package

3375



Code	Weight	Pcs/bag
3375-30	30 gr	2 pcs
3375-40	40 gr	2 pcs
3375-50	50 gr	2 pcs
3375-70	70 gr	2 pcs

Rocket package

3365



Code	Weight	Pcs/bag
3365-30	30 gr	2 pcs
3365-40	40 gr	2 pcs
3365-50	50 gr	2 pcs
3365-70	70 gr	2 pcs





## Method set

Sensitive set

3400



Code	Weight	Pcs/bag
3400-30	30 gr	2+1 pcs
3400-40	40 gr	2+1 pcs
3400-50	50 gr	2+1 pcs
3400-70	70 gr	2+1 pcs

Double Chance Method basket set

3410



Rocket set

3405



Code	Weight	Pcs/bag
3410-30	30 gr	2+1 pcs
3410-40	40 gr	2+1 pcs
3410-50	50 gr	2+1 pcs
3410-70	70 gr	2+1 pcs

Code	Weight	Pcs/bag
3405-30	30 gr	2+1 pcs
3405-40	40 gr	2+1 pcs
3405-50	50 gr	2+1 pcs
3405-70	70 gr	2+1 pcs

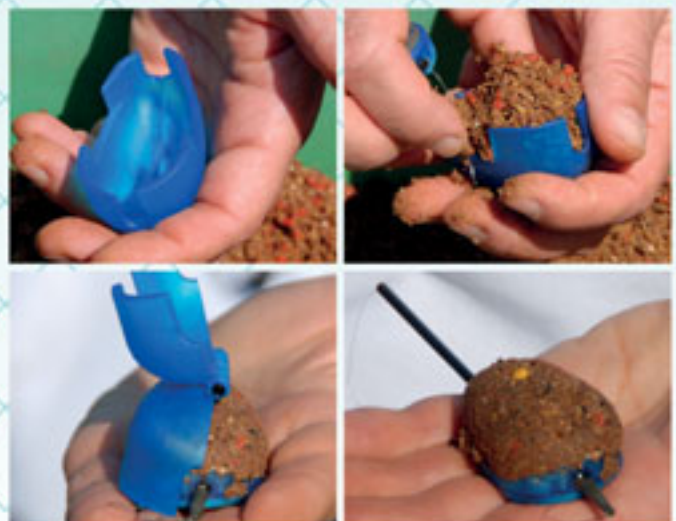



# Method set

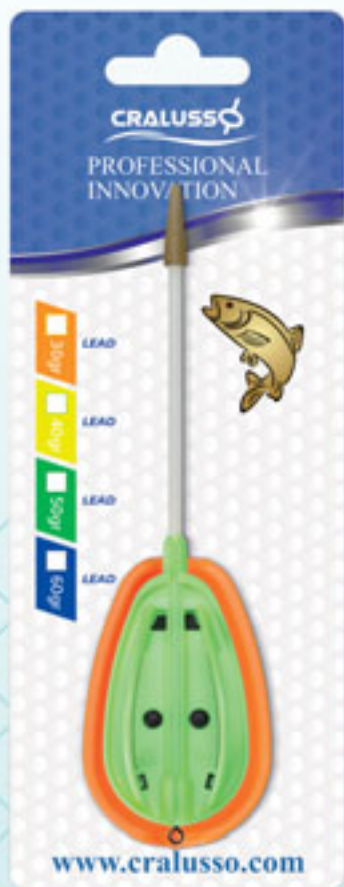

Rocket method set 3420

Code	Weight	
3420-30	30 gr	Fluo green basket + Charger
3420-40	40 gr	Fluo green basket + Charger
3420-50	50 gr	Fluo green basket + Charger
3420-60	60 gr	Fluo green basket + Charger

Plastic-free packaging



Rocket method set 3421

Code	Weight	
3421-30	30 gr	Orange basket + Charger
3421-40	40 gr	Orange basket + Charger
3421-50	50 gr	Orange basket + Charger
3421-60	60 gr	Orange basket + Charger

Plastic-free packaging

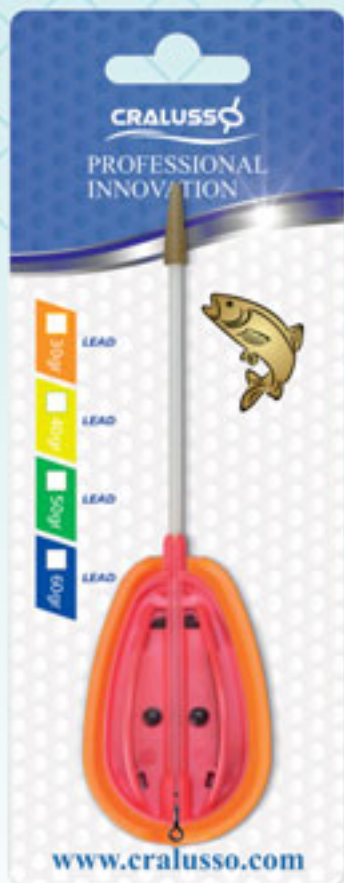

Rocket method set 3422

Code	Weight	
3422-30	30 gr	Pink basket + Charger
3422-40	40 gr	Pink basket + Charger
3422-50	50 gr	Pink basket + Charger
3422-60	60 gr	Pink basket + Charger

Plastic-free packaging



Rocket method set 3323

Code	Weight	
3423-30	30 gr	Crystal basket + Charger
3423-40	40 gr	Crystal basket + Charger
3423-50	50 gr	Crystal basket + Charger
3423-60	60 gr	Crystal basket + Charger

Plastic-free packaging

**NEW** Big Rocket method bascets



The larger version of the popular Rocket method basket can accommodate 30% larger amount of feed. It is especially important for long-distance fishing and frequently installed waters.

Big Rocket method basket 3430

Plastic-free packaging

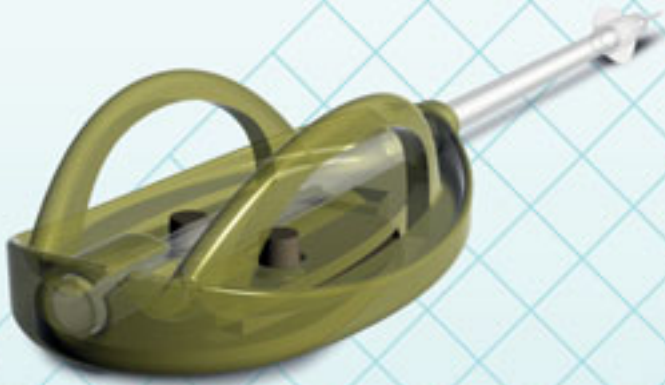

Code	Weight	
3430-30	30 gr	Big Rocket method basket khaki
3430-40	40 gr	Big Rocket method basket khaki
3430-50	50 gr	Big Rocket method basket khaki
3430-70	70 gr	Big Rocket method basket khaki

Big Rocket method basket 3431

Plastic-free packaging



Code	Weight	
3431-30	30 gr	Big Rocket method basket chrystal
3431-40	40 gr	Big Rocket method basket chrystal
3431-50	50 gr	Big Rocket method basket chrystal
3431-70	70 gr	Big Rocket method basket chrystal

Big Rocket method basket 3432

Plastic-free packaging



Code	Weight	
3432-30	30 gr	Big Rocket method basket white
3432-40	40 gr	Big Rocket method basket white
3432-50	50 gr	Big Rocket method basket white
3432-70	70 gr	Big Rocket method basket white

Method basket stem set 3345  
5 pcs/bag





**NEW** Big Rocket method sets

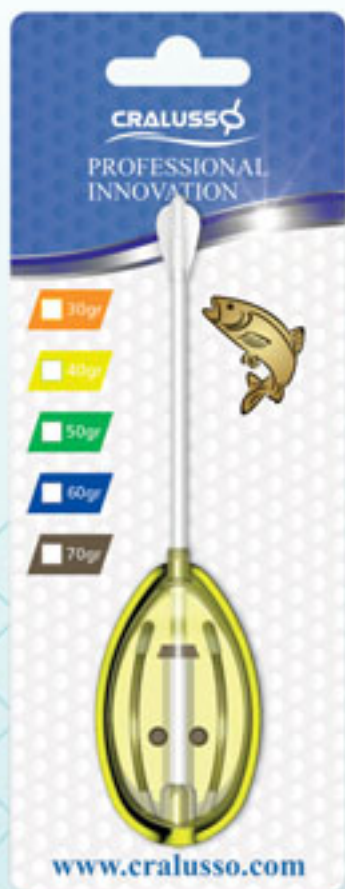

Big Rocket method set 3433

Code	Weight	
3433-30	30 gr	khaki basket + charger
3433-40	40 gr	khaki basket + charger
3433-50	50 gr	khaki basket + charger
3433-70	70 gr	khaki basket + charger

Plastic-free packaging

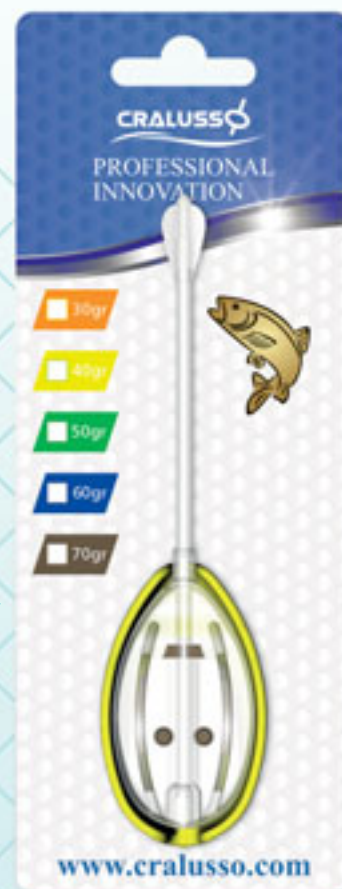

Big Rocket method set 3434

Code	Weight	
3434-30	30 gr	chrystal basket + charger
3434-40	40 gr	chrystal basket + charger
3434-50	50 gr	chrystal basket + charger
3434-70	70 gr	chrystal basket + charger

Plastic-free packaging

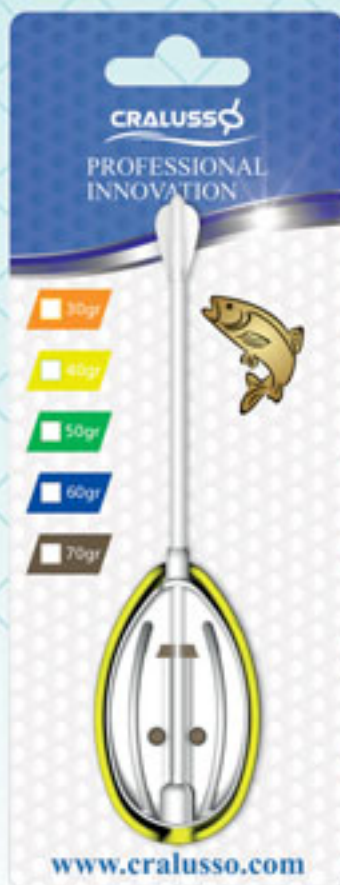

Big Rocket method set 3435

Code	Weight	
3435-30	30 gr	white basket + charger
3435-40	40 gr	white basket + charger
3435-50	50 gr	white basket + charger
3435-70	70 gr	white basket + charger

Plastic-free packaging

**Protected product!**

# Innovative openable method basket quick-fillers without the nuisance of feeding stuff sticking inside. They can be used for a variety of method feeder baskets

## Blue Shell

3350

Internal size 55x34 mm



Patented method fillers that are simple and quick to use. Recommended for anglers using their filler devices holding them in their hands. In addition to Cralusso's method baskets it is also compatible with the competition-size baskets manufactured by Guru, Drennen, Mivardi, Haldorádó etc.



## Orange Shell

3351

Internal size 55x34 mm



Its shape is the same as that of Blue Shell. This self-locking version is recommended for anglers preferring to use their filler devices laid down. In addition to Cralusso's method baskets it is also compatible with the competition-size baskets manufactured by Guru, Drennen, Mivardi, Haldorádó, Topmix etc.



Self-lock patent version!

## Green Shell

3352

Internal size 49x28 mm



An opening quick-filler manufactured for method baskets of the most frequently used sizes and shapes. It can be effectively used with Preston, Energofish, TopMix, Nevis, Haldorádó etc. baskets. It makes filling baskets easier and quicker.



Self-lock patent version!

## Yellow Shell

3353

Internal size 65x37 mm



An opening quick filler to fill up large method baskets. For easy handling of even such extreme materials as glued maggots. Easy to use with Energofish, Haldorádó and other similarly large baskets.

Shell fillers open up new dimensions in method fishing.

Self-lock patent version!



## Feeder Basket

Pellet feeder basket

3018



Code	Weight	Pcs/bag
3018-25	25 gr	2 pcs
3018-35	35 gr	2 pcs
3018-45	45 gr	2 pcs

Special round feeder with wire loop

3020

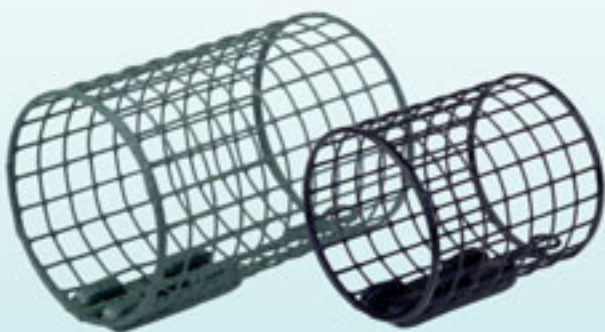

Code	Weight	Pcs/bag
3020-XL	10 gr	2 pcs
3020-XXL	10 gr	2 pcs
3020-XXXL	10 gr	2 pcs

## Weights

Olive weights with silicone,- two functions in one lead

If the line is threaded through the tube, the olivette can be used as a sliding weight.

If fixed to the line by silicon tubes, then it can be used as changeable weight.



3002



Code	Weight	Pcs/bag
3002-1	1,0 gr	5 pcs
3002-1,5	1,5 gr	5 pcs
3002-2	2,0 gr	5 pcs
3002-2,5	2,5 gr	5 pcs
3002-3	3,0 gr	5 pcs
3002-4	4,0 gr	5 pcs
3002-5	5,0 gr	5 pcs
3002-6	6,0 gr	5 pcs
3002-7	7,0 gr	5 pcs
3002-8	8,0 gr	5 pcs
3002-mix	Mixed	5 pcs

3001-mix



Globular weight with central hole, precise cut and protector tube

The quality manufacture and tube makes it possible to fix perfectly centrally and without causing damage



3001



Code	Weight	Pcs/bag
3001-1	1,0 gr	5 pcs
3001-1,5	1,5 gr	5 pcs
3001-2	2,0 gr	5 pcs
3001-2,5	2,5 gr	5 pcs
3001-3	3,0 gr	5 pcs
3001-4	4,0 gr	5 pcs
3001-5	5,0 gr	5 pcs
3001-6	6,0 gr	5 pcs
3001-7	7,0 gr	5 pcs
3001-8	8,0 gr	5 pcs
3001-10	10,0 gr	4 pcs
3001-12	12,0 gr	4 pcs
3001-15	15,0 gr	4 pcs
3001-18	18,0 gr	3 pcs
3001-20	20,0 gr	3 pcs
3001-25	25,0 gr	2 pcs
3001-30	30,0 gr	2 pcs
3001-mix	Mixed	5 pcs

Sounding weight

3003



Code	Weight	Pcs/bag
3003-5	5,0 gr	4 pcs
3003-10	10,0 gr	3 pcs
3003-15	15,0 gr	3 pcs
3003-20	20,0 gr	2 pcs
3003-35	35,0 gr	2 pcs

Fix weight without lead, mix

3062



4 pcs/bag

## Anti tangle

Anti tangle tube with strong end 3101



Code	Size	Pcs/bag
3101-30	30 mm	3 pcs
3101-55	55 mm	3 pcs
3101-85	85 mm	3 pcs
3101-120	120 mm	3 pcs

Anti tangle tube with hooked snap 3102



Code	Size	Pcs/bag
3102-80	80 mm	3 pcs
3102-120	120 mm	3 pcs
3102-180	180 mm	3 pcs

Ballancer boom 3110

15 cm 3 pcs/bag



Semi fixed lead ring 3115

25 cm 3 pcs/bag



T-shirt Royal blue and white, Cralusso logo is in front and back, hard-wearing and fine material.



Code: 9001



Code: 9002



Code: 9003



Code: 9004

Cralusso caps:  
Softish material, adjustable size,  
hard wearing, embroidered in front.



Fleece sweater embroidered  
on both sides  
Code: 9020  
Size:  
M - L - XL - XXL



Innovative Fishing Floats and Accessories  
2023

CRALUSSO,  
CHOICE OF THE WINNERS

Králik & Tsa. Kkt.  
H-2600 Vác, Zrínyi u. 3.  
Phone: +36/27-304-327  
e-mail:cralusso@cralusso.com

[www.cralusso.com](http://www.cralusso.com)

